

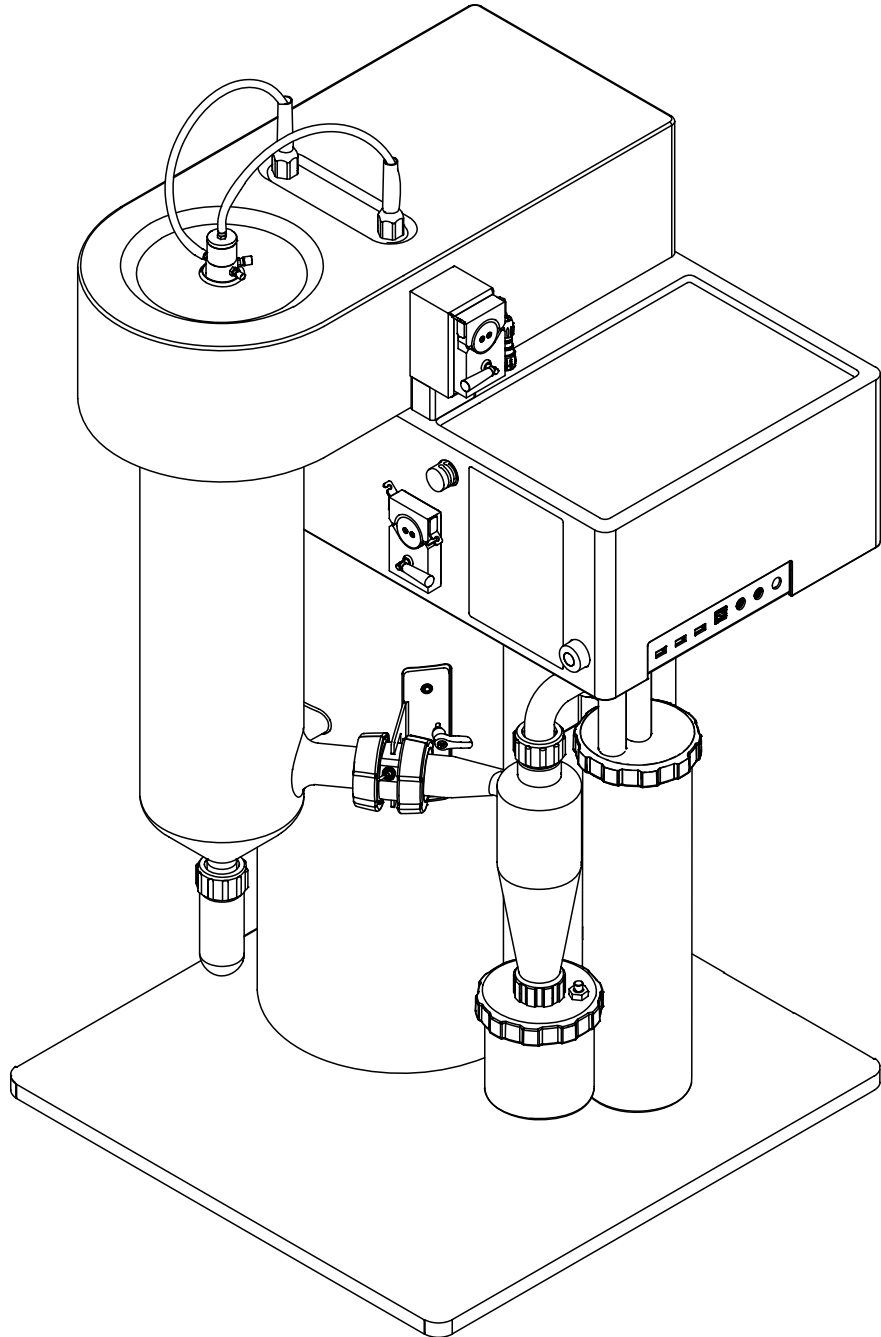

# MiniSprayDryer S-300

Technical data sheet



## Scope of delivery

All configurations are supplied ready to use.

Component	MiniSprayDryer S-300	MiniSprayDryer S-300 Advanced	MiniSprayDryer S-300 Corrosive
	Instrument	1	1
Silicone hose D4/7 L=5m	1	1	1
Two fluid nozzle, complete	1	1	-
Nozzle cleaning brush	1	1	1
Hose clip 25-40 DIN3017	1	1	-
Torx wrench TX 25	1	1	1
Compressed gas hose	1	1	1
Hose adapter 4/2	1	1	1
Hexagonal wrench SW 3.0	1	1	1
Silicone Hose D2/4	1	1	1
Silicone labor cable	1	1	1
Torx wrench TX30	1	1	1
Power supply	1	-	-
Hose Tygon MH2075	1	1	1
Feed switch valve	-	1	-
Cap nut D1.4	-	1	-
Instruction for quick couplings	-	1	-
Hose coupling	1	1	1
Pauch 160x220	-	1	-
Hose Tygon HCF4040A	-	1	-
Two fluid nozzle corrosive, complete	-	-	1
Ultrasonic Package	-	-	-

## Order code

Choose the configuration according to your needs:

**1 1 S 3 0 0**     **1**   **0 0**

Version

- B MiniSprayDryer S-300
- A MiniSprayDryer S-300 Advanced
- C MiniSprayDryer S-300 Corrosive

Auto mode

- 0 No auto mode
- 1 With auto mode (Advanced and Corrosive only)

Temperature

- 0 220°C
- 1 250°C (Advanced and Corrosive only)

## Technical data

### MiniSprayDryer S-300

	MiniSprayDryer S-300	MiniSprayDryer S-300 Advanced	MiniSprayDryer S-300 Corrosive
Dimensions (W x D x H)	620 mm x 640 mm x 1052 mm	620 mm x 640 mm x 1052 mm	620 mm x 640 mm x 1052 mm
Weight (without glass assembly)	54 kg	54 kg	54 kg
Weight (with glass assembly)	62.5 kg	62.5 kg	62.5 kg
Connection voltage	220 - 240 ± 10 % VAC	220 - 240 ± 10 % VAC	220 - 240 ± 10 % VAC
Power consumption	max. 2300 W	max. 2300 W	max. 2300 W
Fuse	10 AT	10 AT	10 AT
Overvoltage category	II	II	II
Frequency	50 / 60 Hz	50 / 60 Hz	50 / 60 Hz
IP Code	IP20	IP20	IP20
Pollution degree	2	2	2
Minimum clearance on all sides	100 mm	100 mm	100 mm
Spray drying gas	Nitrogen Compressed air	Nitrogen Compressed air	Nitrogen Compressed air
Max. temperature	220 / 250 °C	220 / 250 °C	220 / 250 °C
Max. flow rate	35 m³/h	35 m³/h	35 m³/h
Spray gas range	80-1800 l/min	80-1800 l/min	80-1800 l/min
Max. pressure spray gas	7 bar	7 bar	7 bar
Sample feed	0.1-30 ml/min	0.1-30 ml/min	0.1-30 ml/min
External connection drying gas	KF25	KF25	KF25
Certificate	CSA / CE	CSA / CE	CSA / CE

## Ambient conditions

For indoor use only.

Max. altitude above sea level	2000 m
Ambient and storage temperature	5 – 40 °C
Maximum relative humidity	80% for temperatures up to 31 °C decreasing linearly to 50 % relative humidity at 40 °C

## Spare parts and accessories

### Nozzle

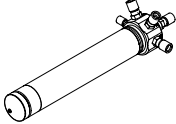
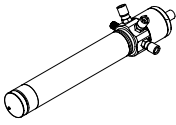
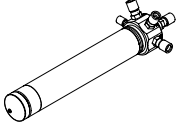
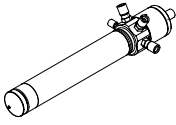
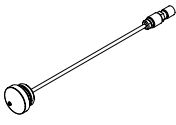
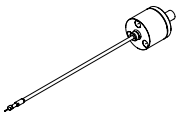
	Order no.	Image
Three fluid nozzle, complete Nozzle for two independent sample feeds at the same time. Allows to spray dry immiscible samples for microencapsulation applications.	046555	
Two fluid nozzle corrosives, complete	11056320	
Three-fluid nozzle corrosives, complete	11056971	
Two-fluid nozzle 0.7 mm, complete	044698	
Three-fluid nozzle conversion kit	046556	
Nozzle cleaning 0.7 mm, complete	044643	

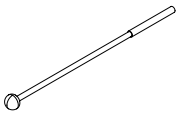
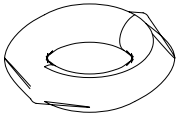
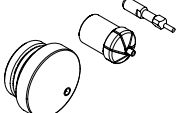
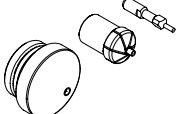
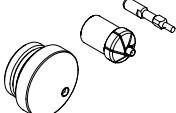
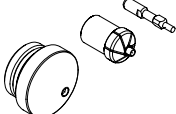
	Order no.	Image
Cleaning brush for nozzle	044782	
O-ring for nozzle cleaner, FKM (black), 2x	044469	
Nozzle exchange set 1.4 mm, complete Wider diameter for the two fluid nozzle to work with viscous sample materials.	046380	
Nozzle set 1.4 mm titanium, complete	11056415	
Nozzle exchange set 2.0 mm, complete Wider diameter for the two fluid nozzle to work with viscous sample materials.	046381	
Nozzle set 2.0 mm titanium, complete	11056416	
Nozzle cleaning acid proof	11059876	

## Nozzle needle

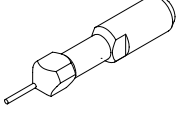
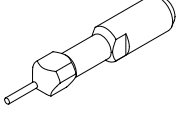
	Order no.	Image
Needle 0.5 mm	11056864	
Needle 0.7 mm titanium	11056315	

	Order no.	Image
Needle 1.4 mm	046372	
Needle 1.4 mm titanium	11056417	
Needle 2.0 mm	046373	
Needle 2.0 mm titanium	11056422	
Nozzle inside 0.7 mm	046554	
Nozzle inside titanium	11056969	
Needle for nozzle cleaning	044618	

## Nozzle tip

	Order no.	Image
Nozzle tip 0.5 mm	11056865	
Nozzle tip 0.7 mm	044634	
Nozzle tip 0.7 mm titanium	11056317	
Nozzle tip 1.4 mm	046376	
Nozzle tip 1.4 mm titanium	11056419	
Nozzle tip 2.0 mm	046377	
Nozzle tip 2.0 mm titanium	11056424	

## Nozzle cap

	Order no.	Image
Nozzle cap 1.4 mm	044649	
Nozzle cap 1.5 mm	044647	
Nozzle cap 1.5 mm titanium	11057509	
Nozzle cap 2.2 mm	046374	
Nozzle cap 2.2 mm titanium	11057510	
Nozzle cap 2.8 mm	046375	
Nozzle cap 2.8 mm titanium	11057511	



## O-rings nozzle

	Order no.	Image
Set of O-rings for nozzle	044759	
O-ring for nozzle, FKM (green), 2x	044645	
O-ring nozzle cap silicone (red), 2x 16.0 x 2.0 mm	002103	
O-ring for needle and nozzle tip, FKM (green), 4x 6.0x1.5 mm	004222	
O-ring for nozzle cleaner, FKM (black), 2x 3.0x1.5 mm	038348	
O-ring FFKM for screw coupling	046363	
O-ring for nozzle tip, FFKM (green), 2x	046361	

## Accessories

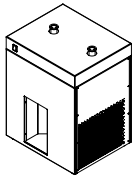
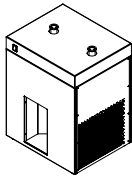
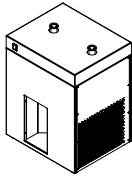
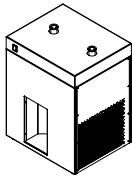
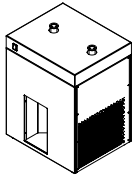
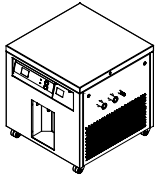
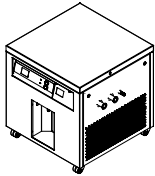
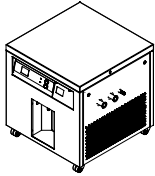
	Order no.	Image
Inert Loop B-295 Upgrade box	11074892	
Dehumidifier S-396 200 V	11073817	
Dehumidifier S-396 220 V	11074006	
Dehumidifier S-396 210 V	11073816	
Dehumidifier S-396 230 V	11073814	
Dehumidifier S-396 240 V	11073815	
Inert Loop S-395 200V 50Hz	11074620	
Inert Loop S-395 230V 50 HZ	11074621	
Inert Loop S-395 200V 60 HZ	11074622	

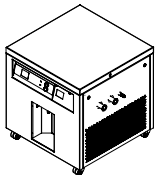
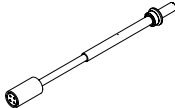
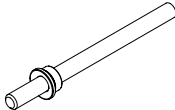
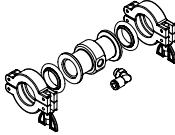
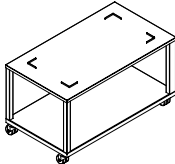
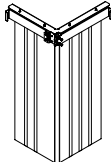
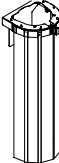
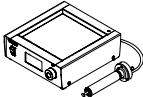
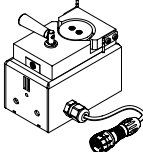
	Order no.	Image
Inert Loop S-395 230V 60 HZ	11074623	
Cable product cover	11071611	
Ground pin Ø4 casing coated	11071709	
Inert gas adapter S-300, complete	11074499	
Trolley S-300	11074575	
Protective curtain right, complete	11071754	
Protective curtain left, complete	11071651	
Ultrasonic package	11069892	
Peristaltic pump external Second peristaltic pump for three fluid nozzle, nozzle cooling or shorter distance between pump and nozzle.	11070786	

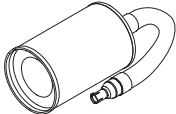
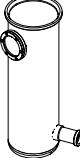
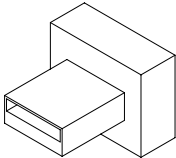
	Order no.	Image
Inlet filter, complete Protects the sample from particles of the environmental drying air. Only for open mode.	011235	
Spray cylinder chrome steel kp	11064367	
Adapter USB-Wi-Fi/Bluetooth	11072500	
Oil-free compressor, 230 V/50 Hz	027907	
Compressed air maintenance unit	004366	
Oil-free compressor, 230 V/60 Hz	11055737	

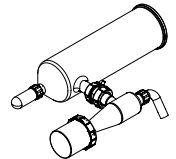
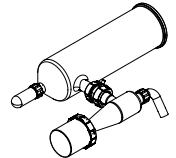
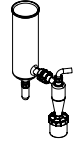
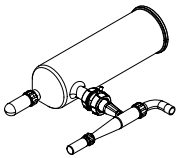

## Glassware

### Glass assembly

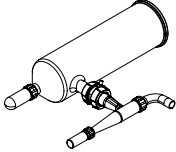
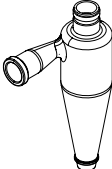
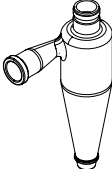
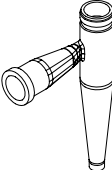
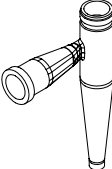
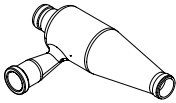
	Order no.	Image
Glass assembly S-300, complete	11071071	
Glass assembly S-300 brown, complete	11073658	
Glass assembly corrosive S-300, complete	11071420	
Glass assembly S-300 HP cyclone, complete	11074494	

	Order no.	Image
Glass assembly S-300 HP cyclone brown, complete	11074495	
<b>Cyclone</b>		
	Order no.	Image
Standard cyclone	004189	
Cyclone brown	11073659	
High-performance cyclone	046368	
High-performance cyclone, brownglass	11056879	
Cyclone with SVL 42	11071060	
High performance cyclone, complete	11074500	
High performance cyclone brown glass, complete	11074496	

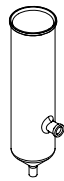
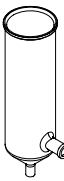
## Spray cylinder

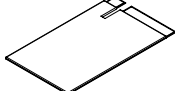

	Order no.	Image
Spray cylinder	044673	
Spray cylinder brown glass	044726	
Spray cylinder, vertical outlet	044697	
Spray cylinder, vertical outlet. brown glass	044728	
Cylinder insulation	040058	

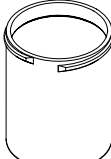
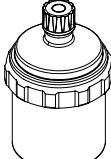
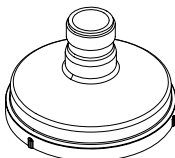
## Collection vessel

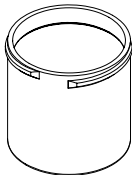
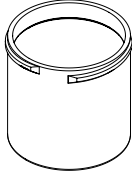
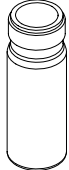
	Order no.	Image
Large collection vessel for standard cyclone 1.1 L	11056990	
Large product collection vessel for HP cyclone, complete	11056899	
Cover for large collection vessel HP cyclone	11056901	

	Order no.	Image
Product collection vessel, brown glass	044727	
Product collection vessel	044678	
Small product collection vessel for HP cyclone	046367	

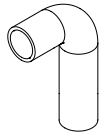
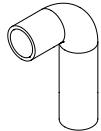
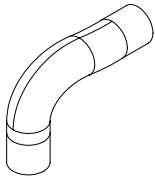
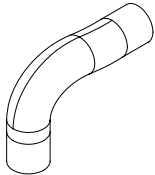
### Other glassware related spare parts



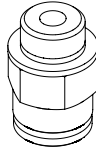
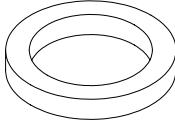
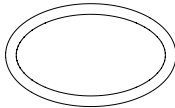
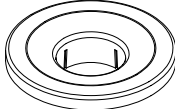

	Order no.	Image
Angle tube	11070485	
Angle tube brown	11073660	
Angle tube for HP cyclone	11073621	
Angle tube for HP cyclone brown	11074322	
Cap nut for cyclone	11070711	

	Order no.	Image
Cover product vessel for cyclone	11072625	
Cover product vessel	11071425	
Coupling flange	11073537	
Coupling flange corrosives	11071421	
Knurled handle with recess	11071059	
Gasket SVL 42x35	11071061	
O-Ring 104 x 6.99 FKM 70	11071062	
Screw cap SVL 42	003551	
Separation flask	004188	



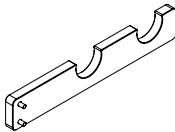
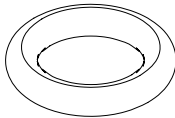
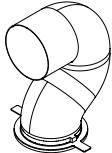
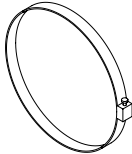

	Order no.	Image
Push in connect NPQH-D-G1/8 Ø6	11071105	
Separation flask	004343	
Gasket FPM to waste vessel	040471	
Silicone seal SVL 42	040674	
Holder to spray cylinder	044710	
O-ring to spray cylinder	044711	
Screw to holder	044712	
Cover to product collection vessel	046318	
Plastic closure for product collection vessel	046358	

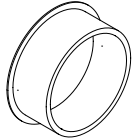
## Spare parts

	Order no.	Image
Set O-ring Plastiperfl. S-300	11074501	
	11071708	
O-ring Ø 5.00x1.50 Plastip.	11074587	
Ventilation hose aspirator, complete	11071064	
Hose clamp	11071067	
O-Ring Ø 27.94x5.33 FKM 75	11071073	
Quick release clamp	11071080	
Clamping lever M4	11071171	
Cover cap Ø 25.4	11071194	

	Order no.	Image
Gasket SVL 42x35 PTFE	11071325	
Fixing nut T-sensor	11073019	
Heater 2.3 kW 200 VAC conf.	11071353	
Outlet filter corrosives, complete	11071410	
Outlet filter corrosive, complete	11071411	
PTFE membrane filter	046316	
Polyester filter bags (6 units)	035004	
Filter holder grounded	11073770	
Adapter T-Sensor Outlet	11073020	

	Order no.	Image
Pt1000 Temp. sensor 380mm coat	11071407	
Pt1000 Temp. sensor 380mm	11072982	
Silicone tube for nozzle cooling, 4 m	004139	
Tygon tube MH2375 transparent (per m)	046314	
Tygon tube F 4040 A yellow (per m)	046315	

## Hoses

	Order no.	Image
Set tube PTFE	11072713	
Set tube PTFE corr.	11072714	
Tube Inert Loop PTFE conf.	11071602	
Hose Inert Loop TPR conf.	11071076	
Set hose TPR corr.	11071432	

	Order no.	Image
Hose filter conf.	11071057	
Set hose dry gas TPR	11071431	
Set tubes for chiller	11073021	
Hose filter conf. corr.	11071413	
Hose TPR 0.7 m conf.	11071051	
Hose TPR 0.7 m conf.	11071052	
Hose TPR 1.0 m conf.	11071053	
Hose PTFE 0.7 m conf.	11071054	
Hose PTFE 0.7 m conf.	11071055	
Hose PTFE 1.0 m conf.	11071056	

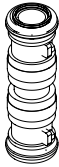
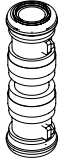
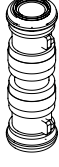
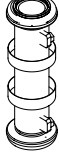
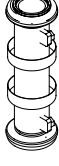
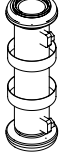
	Order no.	Image
Hose TPR 0.7 m conf. coated	11071603	
Hose TPR 0.7 m conf. coated	11071604	
Hose TPR 1.0 m conf. coated	11071605	
Hose PTFE 0.7 m conf. coated	11071606	
Hose PTFE 0.7 m conf. coated	11071607	
Hose PTFE 1.0 m conf. coated	11071608	

## Documents

	Order no.
Set IQ/OQ S-300 en	11074567
Repeating OQ S-300 en	11074568