

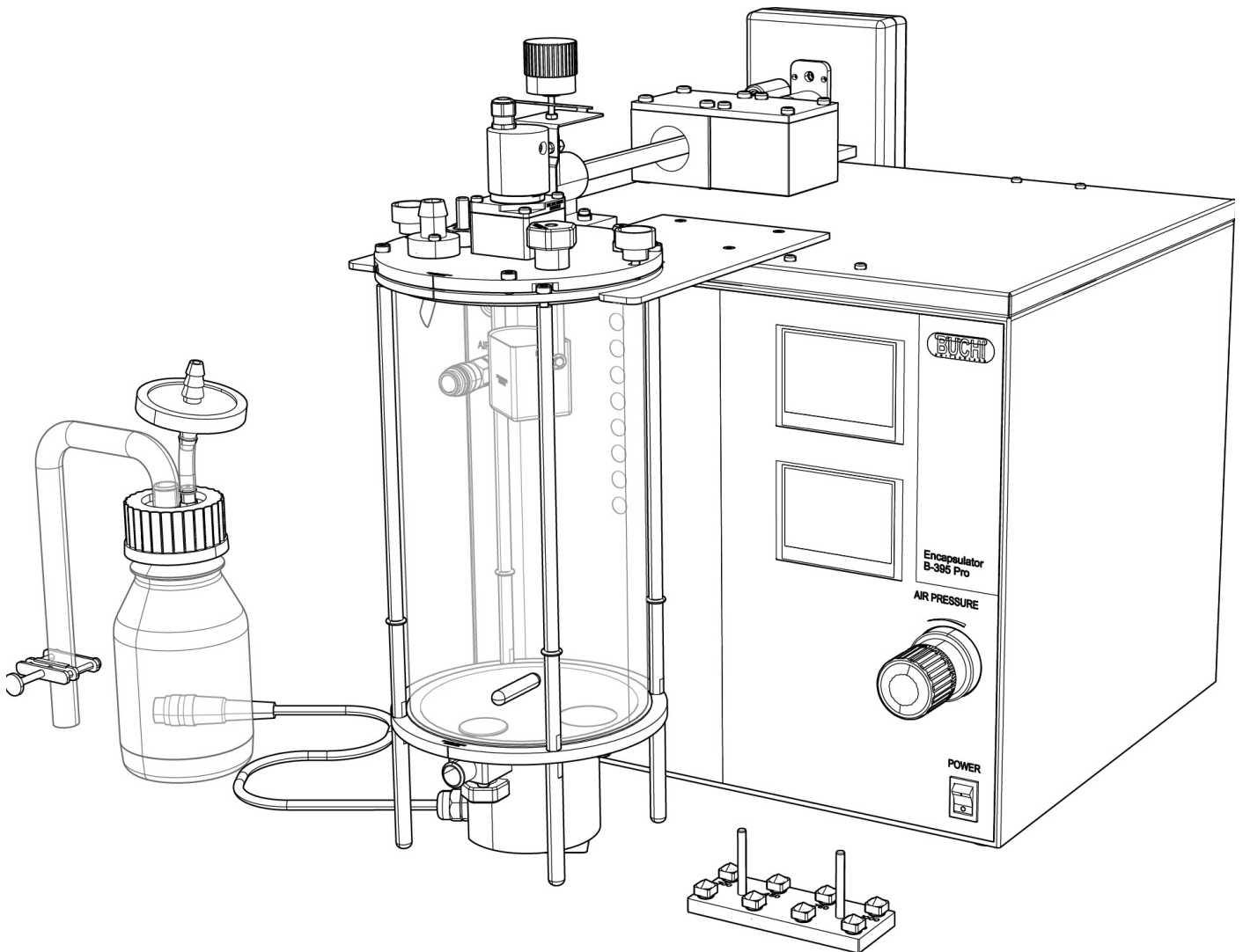

Encapsulator B-395 Pro

Operation Manual



Imprint

Product Identification:
Operation Manual (Original), Encapsulator B-395

11593484E en

Publication date: 05.2016

BÜCHI Labortechnik AG
Meierseggstrasse 40
Postfach
CH-9230 Flawil 1

E-Mail: quality@buchi.com

BUCHI reserves the right to make changes to the manual as deemed necessary in the light of experience; especially in respect to structure, illustrations and technical detail.

This manual is copyright. Information from it may not be reproduced, distributed, or used for competitive purposes, nor made available to third parties. The manufacture of any component with the aid of this manual without prior written agreement is also prohibited.

Table of contents

1	About this manual	5
2	Safety.	6
2.1	User qualification	6
2.2	Proper use	6
2.3	Improper use	6
2.4	Safety warnings and safety signals used in this manual	7
2.5	Product safety.	9
2.5.1	General hazards.	9
2.5.2	Safety measures	10
2.5.3	Built-in safety elements and measures	10
2.6	General safety rules	11
2.7	Disclaimer.	11
3	Technical data	12
3.1	Scope of application and delivery	12
3.1.1	Standard instrument.	12
3.1.2	Standard accessories	13
3.1.3	Optional accessories	14
3.1.4	Recommended spare parts	14
3.2	Technical data.	15
3.3	Materials used.	15
4	Description of function	16
4.1	Functional principle	16
4.2	Connections at the Encapsulator B-395 Pro.	18
5	Putting into operation.	19
5.1	Installation site.	19
5.2	Installing the Encapsulator B-395 Pro	20
5.3	Electrical connections	21
5.4	Assembling of the reaction vessel	22
5.4.1	Cover plate	23
5.4.2	Base plate.	27
5.4.3	Bead collecting flask	29
5.5	Pumping systems	30
5.5.1	Syringe pump	30
5.5.2	Pressure bottle	31

Read this manual carefully before installing and running your system and note the safety precautions in chapter 2 in particular. Store the manual in the immediate vicinity of the instrument, so that it can be consulted at any time.

No technical modifications may be made to the instrument without the prior written agreement of BUCHI. Unauthorized modifications may affect the system safety, the EU conformity or result in accidents.

This manual is copyright. Information from it may not be reproduced, distributed, or used for competitive purposes, nor made available to third parties. The manufacture of any component with the aid of this manual without prior written agreement is also prohibited.

The English manual is the original language version and serves as basis for all translations into other languages.

5.5.3	Installation of the pressure bottle	32
5.6	Option: Concentric nozzle system	33
5.6.1	Mounting of CN nozzles	35
5.7	All parts of the Encapsulator B-395 Pro	36
5.8	Final installation check.	36
6	Operation	37
6.1	Starting up the instrument	37
6.2	Main screens	37
6.3	Menu structure of the control unit	38
6.4	Menu functions of the upper touch screen	39
6.5	Menu functions of the lower touch screen	41
6.5.1	Menu for syringe pump calibration.	42
6.5.2	Selecting a calibrated syringe	43
6.6	Manual air pressure control	44
6.7	Handling the syringe pump	45
6.7.1	Calibrating the syringe pump	45
6.7.2	Selecting a pre-calibrated syringe	45
6.8	Practicing with the Encapsulator, using water	46
6.8.1	Using the syringe pump	46
6.8.2	Using the pressure bottle	49
6.9	Practicing with the Encapsulator, using non-sterile alginate solution	52
6.9.1	Preparation of 1.5 % Na-alginate solution	52
6.9.2	Working with the syringe pump	53
6.9.3	Working with the pressure bottle	56
6.10	Practicing with the Encapsulator, working with the complete reaction vessel	58
6.11	Heat sterilization of the reaction vessel	60
6.12	Sterilization of the pressure bottle	60
6.13	Encapsulation procedure for immobilization of micro-organisms in Ca-alginate beads.	61
6.14	Encapsulation protocol for alginate-PLL-alginate membranes	63
6.15	Theoretical background	66
6.15.1	Bead productivity and cell density	68
7	Maintenance and repairs	71
7.1	Customer service	71
7.2	Housing condition	71
7.3	Sealing conditions.	71
7.4	Cleaning.	72
7.4.1	Cleaning the nozzle after each immobilization run	72
7.4.2	Cleaning a clogged nozzle.	73
7.4.3	Cleaning the reaction vessel and the other vessels	73
8	Troubleshooting	74
8.1	Malfunctions and their remedy.	74
9	Shutdown, storage, transport and disposal	75
9.1	Storage and transport	75
9.2	Disposal.	76
10	Declarations and requirements.	77
10.1	FCC requirements (for USA and Canada)	77
10.2	Health and Safety Clearance	78

1 About this manual

This manual describes the Encapsulator B-395 Pro. It provides all information required for its safe operation and to maintain it in good working order. It is addressed to laboratory personnel in particular. If the instrument is used in a manner not specified in this manual, the protection provided by the instrument may be impaired.

Abbreviations

<i>EPDM</i>	Ethylene Propylene Dimonomer
<i>FEP</i>	Fluorelastomer
<i>PTFE</i>	Polytetrafluoroethylene

2 Safety

This chapter points out the safety concept of the instrument and contains general rules of behavior and warnings from direct and indirect hazards concerning the use of the product.

For the user's safety all safety instructions and the safety messages in the individual chapters shall strictly be observed and followed. Therefore, the manual must always be available to all persons performing the tasks described herein.

2.1 User qualification

The instrument may only be used by laboratory personnel and other persons, who on account of training and professional experience know the dangers, which can develop when operating the instrument.

Untrained personnel or persons, who are currently being trained, require careful supervision by a qualified person. The present Operation Manual serves as a basis for training.

2.2 Proper use

The Encapsulator B-395 Pro has been designed and built as laboratory instrument.

The Encapsulator B-395 Pro is a semi-automated instrument used for the polymer encapsulation of chemical substances, bio-molecules, drugs, flavor & fragrances, pigments, extracts, cells and micro-organisms under sterile and non-sterile conditions. The bead formation is based on the fact that a controlled, laminar liquid jet is broken into equally sized beads, if vibrated at an optimal frequency.

The Encapsulator B-395 Pro provides just such controlled conditions to generate beads between 0.15 to 2 mm. The instrument is ideally suited to encapsulate particles < 50 µm.

If the instrument is used with potentially toxic or hazardous substances, it has to be installed inside a closed fume hood or glove box. In such case, the complete processing and system handling has to be performed within the ventilated box to avoid toxication and other hazardous situations to the user and the environment.

2.3 Improper use

Applications not mentioned in section 2.2 are considered to be improper. Applications which do not comply with the technical data (see section 3 of this manual) are also considered to be improper.

The operator bears the sole risk for any damages or hazards caused by improper use!



The following uses are expressly forbidden:

- Installation or use of the instrument in rooms, which require ex-protected instruments.

2.4 Safety warnings and safety signals used in this manual

DANGER, WARNING, CAUTION and NOTICE are standardized signal words for identifying risk levels, related to personal injury and property damage. All signal words, which are related to personal injury are accompanied by the general safety sign.

For your safety it is important to read and fully understand the below table with the different signal words and their definitions!

Sign	Signal word	Definition	Risk level
	DANGER	Indicates a hazardous situation which, if not avoided, will result in death or serious injury.	★★★★★
	WARNING	Indicates a hazardous situation which, if not avoided, could result in death or serious injury.	★★★★☆
	CAUTION	Indicates a hazardous situation which, if not avoided, may result in minor or moderate injury.	★★★☆☆
no	NOTICE	Indicates possible property damage, but no practices related to personal injury.	★☆☆☆☆ (property damage only)

Supplementary safety information symbols may be placed in a rectangular panel on the left to the signal word and the supplementary text (see below example).



Space for supplementary safety information symbols.	 SIGNAL WORD
	Supplementary text, describing the kind and level of hazard/risk seriousness. <ul style="list-style-type: none"> List of measures to avoid the herein described, hazard or hazardous situation.

Table of supplementary safety information symbols

The below reference list incorporates all safety information symbols used in this manual and their meaning.

Symbol	Meaning
	General warning
	Electrical hazard

	Explosive gases, explosive environment
	Harmful to live-forms
	Device damage
	Pressurized gas/air
	Wear laboratory coat
	Wear protective goggles
	Wear protective gloves

Additional user information

Paragraphs starting with NOTE transport helpful information for working with the device/software or its supplementaries. NOTES are not related to any kind of hazard or damage (see example below).

NOTE

Useful tips for the easy operation of the instrument/software.



2.5 Product safety



Safety warnings in this manual (as described in *section 2.4*) serve to make the user alert and to avoid hazardous situations emanating from residual dangers by giving appropriate counter measures. However, risks to users, property and the environment can arise when the instrument is damaged, used carelessly or improperly.



2.5.1 General hazards

The following safety messages show hazards of general kind which may occur when handling the instrument. The user shall observe all listed counter measures in order to achieve and maintain the lowest possible level of hazard.



Additional warning messages can be found whenever actions and situations described in this manual are related to situational hazards.

 	 Warning
	<p>Death or serious injuries by use in explosive environments.</p> <ul style="list-style-type: none"> • Do not operate the instrument in explosive environments. • Do not operate the instrument with explosive gas mixtures. • Before operation, check all gas connections for correct installation. • Directly withdraw released gases and gaseous substances by sufficient ventilation.

 	 Warning
	<p>Pressure increasing in the inlet-system due to clogged nozzles.</p> <p>Bursting of the inlet system.</p> <p>Death or serious poisoning by contact or incorporation of harmful substances at use.</p> <ul style="list-style-type: none"> • Clean nozzle immediately after use, see <i>section 7.4</i>.

	 Warning
	<p>Death or serious injuries by contact with high voltage.</p> <ul style="list-style-type: none"> • Only open the housing of the product when machine is switched off and unplugged.

	Notice
	<p>Risk of instrument short-circuits and damage by liquids.</p> <ul style="list-style-type: none"> • Do not spill liquids over the instrument or parts of it. • Wipe off any liquids instantly. • Ensure a safe positioning of the sample vessel. • Do not move the instrument when it is loaded with liquid. • Keep external vibrations away from the instrument.

 	<p style="text-align: center;">Notice</p> <p>Risk of instrument damage by wrong mains supply.</p> <ul style="list-style-type: none"> • External mains supply must meet the voltage given on the type plate. • Check for sufficient grounding.
	<p style="text-align: center;">Notice</p> <p>Risk of damaging laboratory glasses or utensils by moving syringe pump unit.</p> <ul style="list-style-type: none"> • Do not place any laboratory glasses or other utensils on the Encapsulator.

2.5.2 Safety measures

Always wear personal protective equipment such as protective eye goggles, protective clothing, and gloves when working with the instrument.

2.5.3 Built-in safety elements and measures

High voltage and electrostatic charges

- Safety current limitation.
- Internal grounding to arrest electrostatic charges.

Air/Gas

- Over pressure safety valve (opens at 1.5 bar)

2.6 General safety rules

Responsibility of the operator

The head of laboratory is responsible for training his personnel.

The operator shall inform the manufacturer without delay of any safety-related incidents which might occur during operation of the instrument. Legal regulations, such as local, state and federal laws applying to the instrument must be strictly followed.

Duty of maintenance and care

The operator is responsible for the proper condition of instrument at use and that maintenance, service and repair jobs are performed with care and on schedule by authorized personnel only.

Spare parts to be used

Use only genuine consumables and genuine spare parts for maintenance to assure good system performance and reliability. Any modifications to the spare parts used are only allowed with the prior written permission of the manufacturer.

Modifications

Modifications to the instrument are only permitted after prior consultation with and with the written approval of the manufacturer. Modifications and upgrades shall only be carried out by an authorized BUCHI technical engineer. The manufacturer will decline any claim resulting from unauthorized modifications.

2.7 Disclaimer

Use and marketing of any material produced with the Encapsulator are in the sole responsibility of the operator.

3 Technical data

This chapter introduces the reader to the instrument and its specifications. It contains the scope of delivery, technical data, requirements and performance data.

3.1 Scope of application and delivery

The Encapsulator B-395 Pro is available

- for sterile working conditions in a closed reaction vessel
- with one integrated syringe pump.

The scope of delivery can only be checked according to the individual delivery note and the listed order numbers.

NOTE

For additional information about the listed products, see www.buchi.com or contact your local dealer.

3.1.1 Standard instrument



Table 3-1: Standard instrument

Product	Order no.
Encapsulator B-395 Pro 50 – 60 Hz, 100 – 240 V	11058220
Encapsulator B-395 Pro 50 – 60 Hz, 100 – 240 V with GMP documentation	11058230
Complete Encapsulator B-395 Pro system for sterile procedures with integrated syringe pump, magnetic stirrer and closed reaction vessel.	

3.1.2 Standard accessories

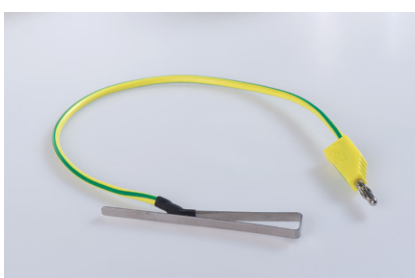

Table 3-2: Standard accessories

Product	Order no.
Reaction vessel	11057890
Reaction vessel with GMP documentation	11057879
Completely autoclavable reactor made of glass and stainless steel for the sterile production and collection of microcapsules, 2 litre working volume	
Set of 8 single nozzles	11057918
Set of 8 single nozzles with high precision opening of 0.08, 0.12, 0.15, 0.20, 0.30, 0.45, 0.75 and 1.00 mm, made of stainless steel 316L including nozzle rack	
Pressure bottle 500 mL	11058190
Pressure bottle 1000 mL	11058191
Glass bottles with fittings, tubes and air filter, working pressure up to 1.5 bar, autoclavable	
Grounding set	11058189
Operation Manual English	11593484

3.1.3 Optional accessories



Table 3-3: Optional accessories

Product	Order no.
Concentric nozzle set	11058051
Set of 7 external nozzles with high precision opening of 0.2, 0.3, 0.4, 0.5, 0.6, 0.7 and 0.9 mm made of stainless steel, incl. 1000 mL pressure bottle	

3.1.4 Recommended spare parts

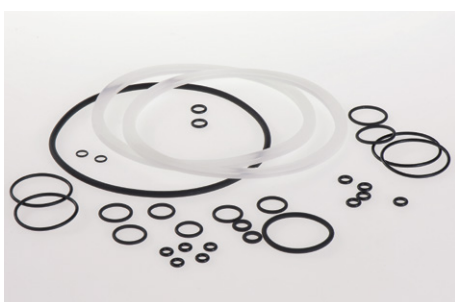
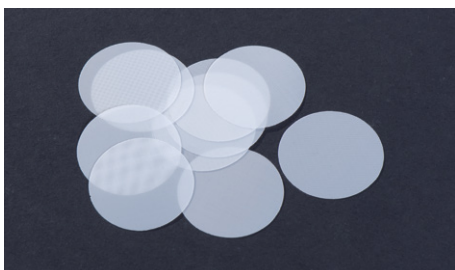

Table 3-4: Recommended spare parts

Product	Order no.
O-ring set for single nozzle	11057954
O-ring set for concentric nozzle	11057955
O-ring set for reaction vessel	11057970



Pre-filters for nozzle, diameter 7 mm (10 pcs.)	11057957
Drain filters for reaction vessel, diameter 35 mm (10 pcs.)	11057958

3.2 Technical data

Table 3-5: Technical data Encapsulator B-395 Pro

Power consumption	max. 150 W	
Connection voltage	100–240 VAC	
Mains supply voltage fluctuations	up to $\pm 10\%$ of the nominal voltage	
Frequency	50/60 Hz	
Fuse	3.15 A	
Dimensions (W×H×D)	32×38×48 cm	
Weight	11 kg	
Nozzle diameter of single (= core) nozzles	0.08, 0.12, 0.15, 0.20, 0.30, 0.45, 0.75 and 1.00 mm	
Nozzle diameter of shell nozzles	0.20, 0.30, 0.40, 0.50, 0.60, 0.70 and 0.90 mm	
Droplet size range	0.15 to 2.00 mm	
Vibration frequency	40 to 6,000 Hz	
Electrode tension	250 to 2,500 V	
Syringe pump rate	0.01 to 50 mL/min	
Pump rate by air pressure	0.5 to 200 mL/min	
Maximal allowed air pressure in the system	1.5 bar	
Reactor gross volume	4.5 liter	
Reactor working volume	2 liter	
Parts in contact with medium	autoclavable	
Sterile working conditions	full	
Overvoltage category	II	
Pollution degree	2	
Environmental conditions:		
Temperature	5–40 °C	for indoor use only
Altitude	up to 2000 m	
Max. relative humidity (curve parameter)	Maximum relative humidity 80 % up to 31 °C, then decreasing linearly to 50 % relative humidity at 40 °C	

Table 3-6: Material and Approvals

Material in contact with sample	stainless steel, silicone, glass, FEP, PTFE
Approvals	CE, CSA

3.3 Materials used

Table 3-7: Materials used

Component	Material description
Reactor	Stainless steel, 3.3 boroscillate glass, FEP, PTFE sealings: silicone, EPDM
Nozzles	Stainless steel, sealings: EPDM
Pressure bottle	Stainless steel, 3.3 boroscillate glass, FEP, PTFE sealings: silicone, EPDM

4 Description of function

This chapter explains the basic working principle of the Encapsulator B-395 Pro. It also shows how the instrument is structured and provides a general functional description of its assembly.

4.1 Functional principle

The instrument provides the following key functions:

Sterile working conditions in a closed reaction vessel

- Sterile containment in an autoclavable reaction vessel.

Reproducible bead size from one production to the next

- Adjustable parameters (nozzle size, liquid flow rate and vibration frequency) determine bead size.

Reproducible bead formation

- In the range of 0.15 mm to 2.0 mm.

High bead size uniformity

- Due to the integrated Electrostatic Dispersion Unit (*EDU*); approximately 5 % relative standard deviation of bead size using pure alginate.

Immediate process control

- Visual monitoring in the light of a stroboscope lamp.

High cell viability

- Bead formation technique is at low shear stress and under physiological conditions, thus resulting in high cell survival.

Batch size

- When using syringes the batch size is of 2 mL to 60 mL and the dead volume is approximately 0.5 mL. When using air pressure for pumping the batch size is of 5 mL to 1'000 mL and the dead volume is approximately 2 mL.

Set of 8 single nozzles

- The 8 nozzle sizes of 0.08, 0.12, 0.15, 0.20, 0.30, 0.45, 0.75 and 1.0 mm cover the bead size range of approximately 0.15 mm to 2.0 mm.

Delivery of the polymer mixture

- By the integrated syringe pump or by air pressure with flow rates from 70 mL/h (0.08 mm nozzle) to 2'500 mL/h (1.0 mm nozzle).

High bead production

- Up to 6000 beads are produced per second depending on encapsulation conditions and polymer mixture.

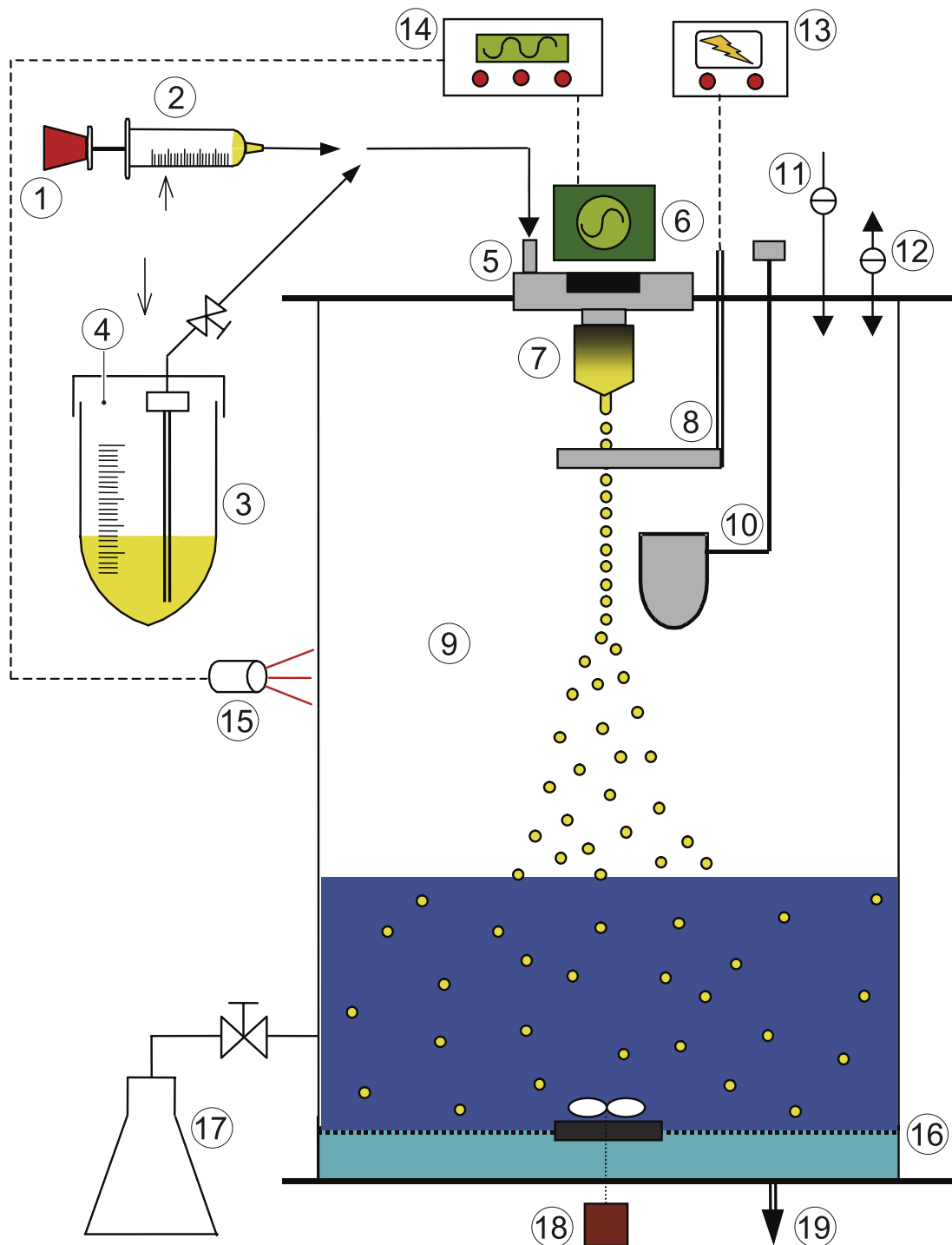

Figure 4-1: Schematic representation of the Encapsulator B-395 Pro

- | | |
|------------------------|----------------------------------|
| ① Syringe pump | ⑪ Liquid filter |
| ② Syringe | ⑫ Air filter |
| ③ Pressure bottle | ⑬ Electrostatic charge generator |
| ④ Air Pressure control | ⑭ Frequency generator |
| ⑤ Pulsation chamber | ⑮ Stroboscope lamp |
| ⑥ Vibration system | ⑯ Filtration grid |
| ⑦ Nozzle | ⑰ Bead collecting flask |
| ⑧ Electrode | ⑱ Magnetic stirrer |
| ⑨ Reaction vessel | ⑲ Waste port |
| ⑩ Bypass cup | |

The main parts of the Encapsulator B-395 Pro are the control unit, with the syringe pump, the electrical and pneumatic systems, and the reaction vessel. All parts of the instrument which are in direct contact with the beads can be sterilized by autoclaving.

The product to be encapsulated (cells, microorganisms, or other biologicals and chemicals) is mixed with an encapsulating polymer (typically alginate) and the mixture put into a syringe ② or a pressure bottle ③, see *figure 4-1*. The polymer-product mixture is forced into the pulsation chamber ⑤ by either a syringe pump ① or by air pressure ④. The liquid then passes through a precisely drilled nozzle ⑦ and separates into equal size droplets on exiting the nozzle. These droplets pass through an electrical field between the nozzle ⑦ and the electrode ⑧ resulting in a surface charge. Electrostatic repulsion forces disperse the beads as they drop to the hardening solution.

Bead size

The bead size is controlled by several parameters including the vibration frequency, amplitude, nozzle size, flow rate, and physical properties of the polymer-product mixture. In general, the bead diameter of Ca-alginate beads is twice the nozzle diameter. But, by varying the jet velocity and the vibration frequency, the range can be adjusted by about $\pm 15\%$.

Optimal parameters for bead formation are indicated by visualization of real-time bead formation in the light of a stroboscope lamp ⑮. When optimal parameters are reached, a standing chain of droplets is clearly visible. Once established, the optimal parameters can be preset for subsequent bead production runs with the same encapsulating polymer-product mixture. Poorly formed beads, which occur at the beginning and end of production runs, are intercepted by the bypass cup ⑩.

Depending on several variables, 50 to 5000 beads are generated per second and collected in a hardening solution within the reaction vessel ⑨. Solutions in the reaction vessel are continuously mixed by a magnetic stir bar ⑯ to prevent bead clumping. In addition, the reaction vessel and/or solution must be electrically grounded. At the conclusion of the production run, the hardening solution is drained off (waste port ⑲), while the beads are retained by a filtration grid ⑯. Washing solutions, or other reaction solutions, are added aseptically through a sterile filter ⑪. The beads can be further processed into microcapsules, or transferred to the bead collecting flask ⑰.

4.2 Connections at the Encapsulator B-395 Pro

Front connections (See *figure 5-2*)

- Main switch
- Air out
- Voltage
- Ground

Rear connections (See *figure 5-1*)

- Electric supply
- Air inlet
- Magnetic stirrer
- Vibration
- Optional plug

5 Putting into operation

This chapter describes how the instrument has to be installed. It also gives instructions for the initial startup.



NOTE





Inspect the instrument for damages during unpacking. If necessary, prepare a status report immediately to inform the postal company, railway company or transportation company. Keep the original packaging for future transportation.

5.1 Installation site

Put the instrument on a stable, horizontal surface. Consider the maximum product dimensions and weight. The instrument must be set up in such a way that the main switch and the mains plug are easily accessible at all times.

Obtain the environmental conditions as described in section 3.2 "Technical data".

	 Warning
	<p>Death or serious injuries by use in explosive environments.</p> <ul style="list-style-type: none"> Do not operate the instrument in explosive environments.

   	 Warning
	<p>Death or serious poisoning by contact or incorporation of harmful substances.</p> <ul style="list-style-type: none"> Wear safety goggles. Wear safety gloves. Wear a laboratory coat. Clean the instrument and all accessories thoroughly to remove possibly dangerous substances. Do not clean dusty parts with compressed air. Store the instrument and its accessories at a dry place.

5.2 Installing the Encapsulator B-395 Pro

Place the instrument on the lab bench with convenient access to an AC electrical outlet and to compressed air. Place the instrument in a way that disconnection of the electric supply plug is possible at all times.

Installation of the magnetic stirrer, vibration unit and grounding wire

Connect the magnetic stirrer, the vibration unit and the grounding wire as shown in *figure 5-1* and *5-2*.

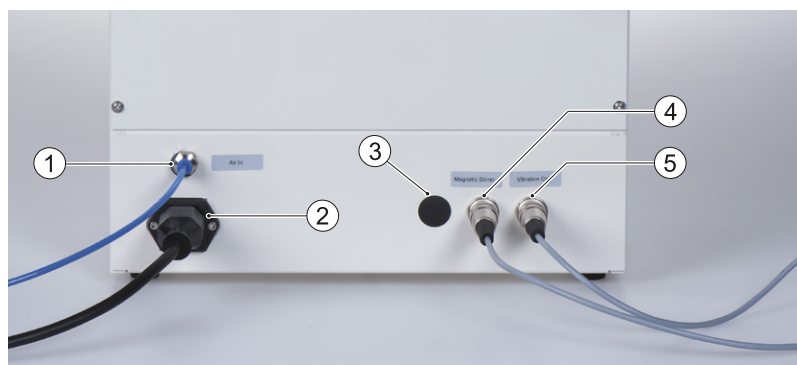

- ① Air inlet (blue tube 2.6×4.0 mm)
- ② Electric supply socket with integrated fuse
- ③ Optional socket
- ④ Socket for magnetic stirrer
- ⑤ Socket for vibration unit

Figure 5-1: Rear view of the control unit

All controlling systems for bead production are incorporated in the control unit. Vibration frequency, pump speed, light intensity, electrostatic dispersion and magnetic stirrer speed are controlled on the two touch screens. Air pressure is regulated with the pressure regulating valve. The integrated stroboscope lamp allows real time jet breakup control. The vibration unit is attached to the control unit on the rear panel by a wire. The reaction vessel is attached to the reactor holder with two screws.



- ① Syringe pump
- ② Reactor holder
- ③ Vibration unit
- ④ Upper touch screen (vibration frequency & electrode)
- ⑤ Lower touch screen (syringe pump, magnetic stirrer control & pressure indication)
- ⑥ Pressure regulating valve
- ⑦ Stroboscope lamp
- ⑧ Mains switch
- ⑨ Magnetic stirrer
- ⑩ Air outlet
- ⑪ EDU (Voltage outlet)
- ⑫ Plug for grounding wire
- ⑬ Liquid flow regulating valve

Figure 5-2: Front view of the control unit

Installation of the air line

A 3 m air tube (2.6×4.0 mm) is included with each Encapsulator to connect it to external compressed air or nitrogen.



1. Stick the air tube into the air inlet plug.
2. Attach the other side of the air tube to the external gas supply.
3. Deliver gas to the Encapsulator at 1.5 to 2 bar (23 to 30 psi) when running the instrument.

NOTE

The integrated pneumatic system (valve and fittings) will tolerate up to 7 bar (100 psi) at the inlet. An over pressure safety valve, which opens at 1.5 bar, is incorporated after the pressure regulating valve, so that the maximum air pressure at the air outlet is 1.5 bar. However the working range is 0 to 1 bar.

5.3 Electrical connections

Verify that the electrical requirement of the unit, stated on the type plate of the control unit, corresponds to voltage of your local electrical network. Connect the power plug of the Encapsulator to the mains supply.

 	<p>⚠ Caution</p> <p>Risk of instrument damage by wrong mains supply.</p> <ul style="list-style-type: none"> • External mains supply must meet the voltage given on the type plate. • Check for sufficient grounding. • Additional electrical safety measures such as residual current breakers may be necessary to meet local laws and regulations! External connections and extension lines must be provided with an earthed conductor lead (3-pole couplings, cord or plug equipment). All used power cords shall be equipped with molded plugs only to avoid risks due to unobservant defective wiring.
--	--

5.4 Assembling of the reaction vessel

The Reaction vessel forms a closed, autoclavable unit in which the beads are formed under sterile conditions and can be further processed if neede

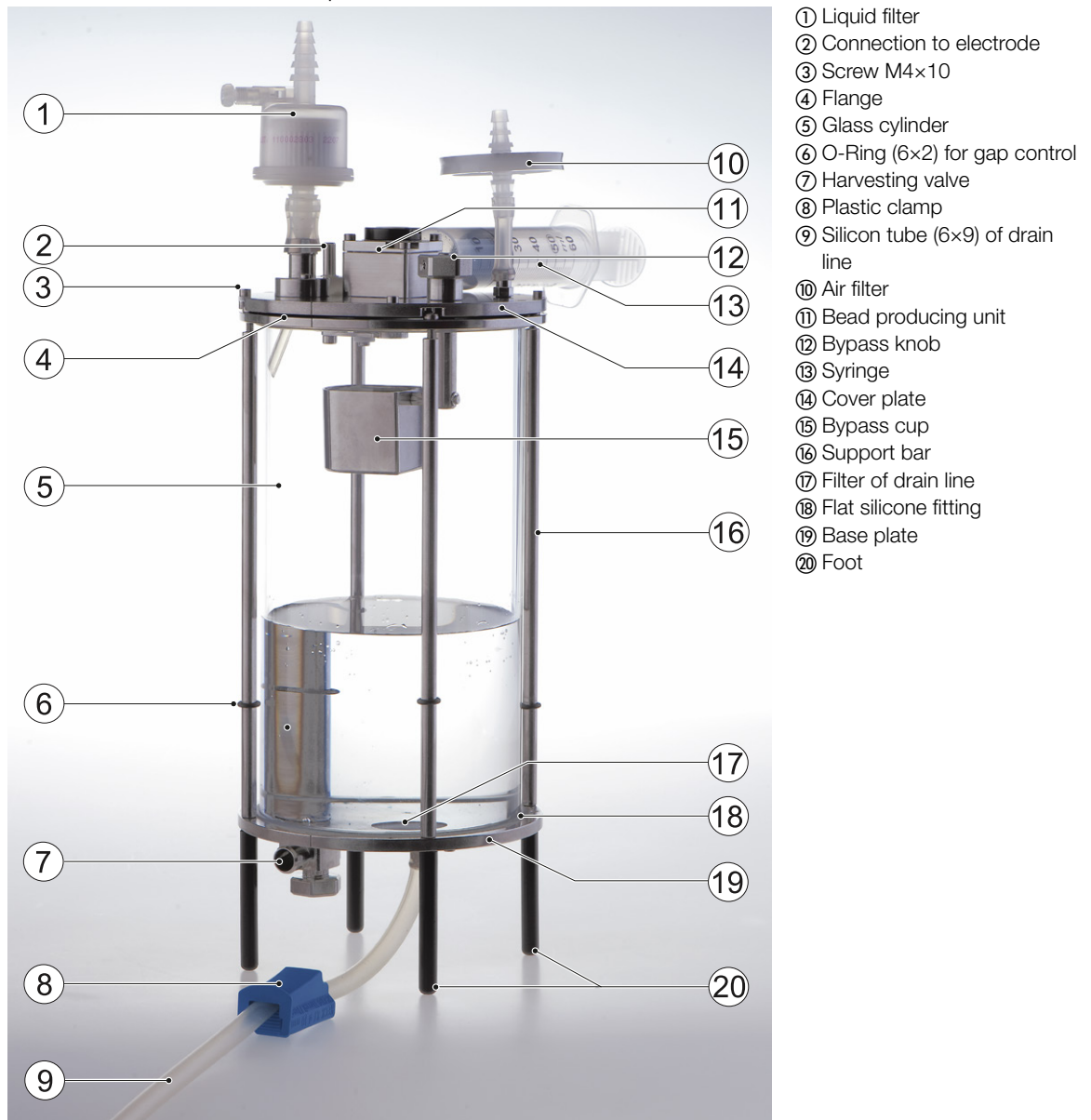

Figure 5-3: General view of the reaction vessel

The reaction vessel's main parts are:

1. Stainless steel cover plate with electrode, bypass, liquid inlet, and air exchange filter
2. Bead producing unit
3. Nozzle
4. Glass cylinder
5. Stainless steel base plate with bead and drain valve
6. Bead collecting flask

5.4.1 Cover plate

The cover plate is delivered with all pieces in place. Before use, wash the cover plate carefully. After each run, disassemble the bead producing unit and the nozzle. Wash with water or appropriate detergent or solvent (according to the nature of the immobilization mixture used), rinse with water and let dry. Be careful not to damage the PTFE membrane while handling the bead producing unit. The other parts should be disassembled only as needed. Wash with detergent, rinse with water and let dry.

When reassembling, check the integrity of the flat fittings and o-ring seals – replace if needed.

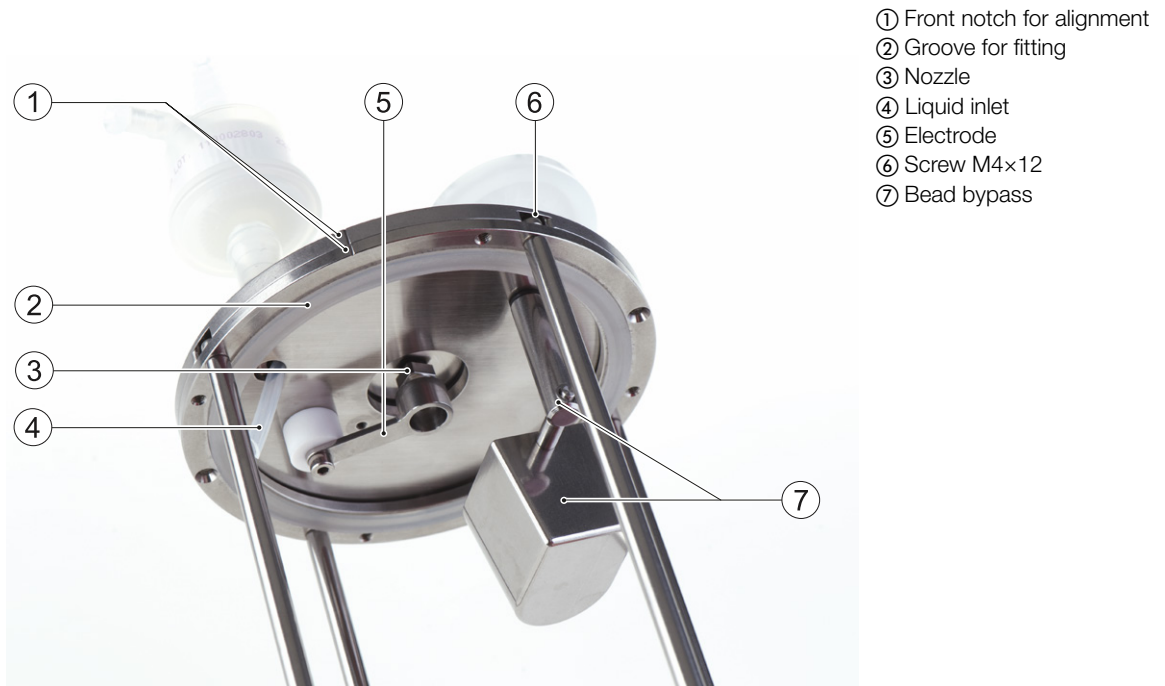

Figure 5-4: Bottom view of mounted cover plate

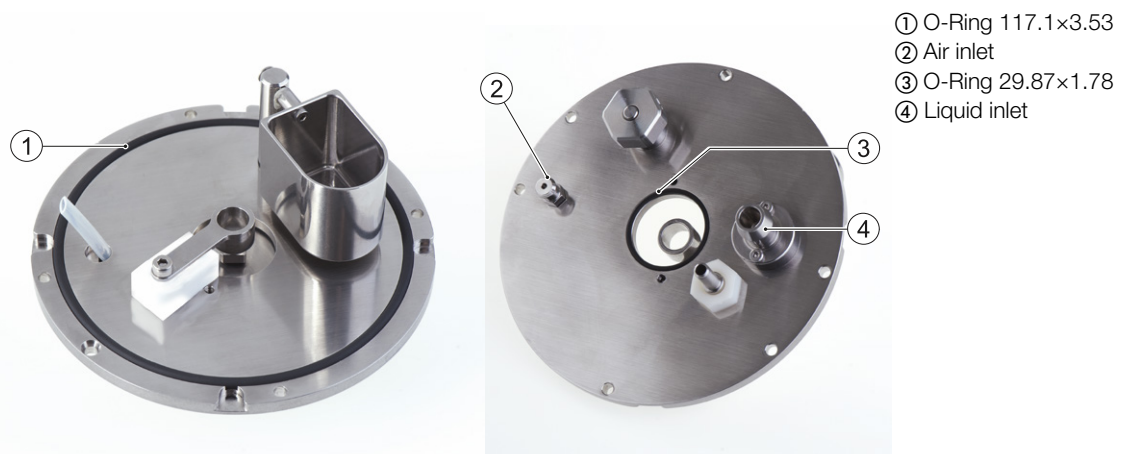
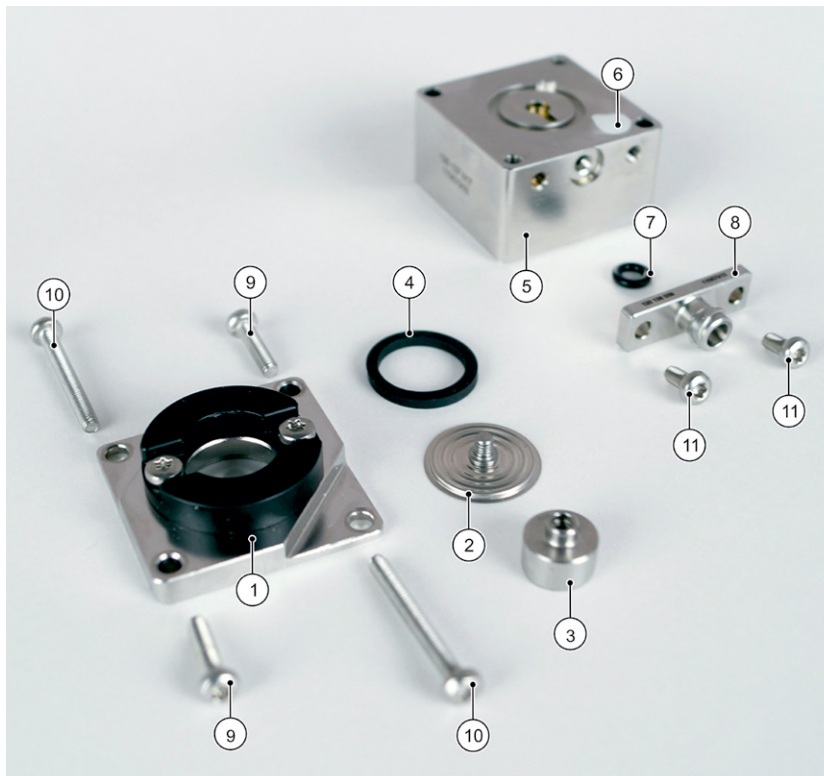

Figure 5-5: Bottom view (left) and top view (right) of cover plate

5.4.1.1 Bead producing unit and nozzles



- ① Magnet holder *
- ② Membrane
- ③ Magnet
- ④ Flat gasket (14×1.78)
- ⑤ Pulsation chamber
- ⑥ Pre-filter with 50 µm mesh
- ⑦ O-Ring (3.68×1.78)
- ⑧ Luer Lock
- ⑨ Screw M3×8
- ⑩ Screw M3×25
- ⑪ Screw M3×6

*with attached fixation ring and screws M3×5.
You can remove the fixation ring for cleaning.

Figure 5-6: Parts of the bead production unit

A high quality nozzle is crucial for homogenous bead production. The holes of the Encapsulator nozzles are precisely drilled using the newest technology. Every Encapsulator B-395 Pro is delivered with a set of 8 nozzles; nozzle aperture sizes are 80, 120, 150, 200, 300, 450, 750 µm and 1.0 mm. They are made completely of stainless steel.

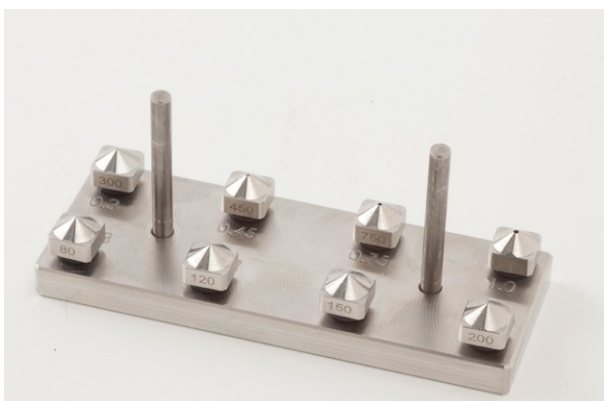
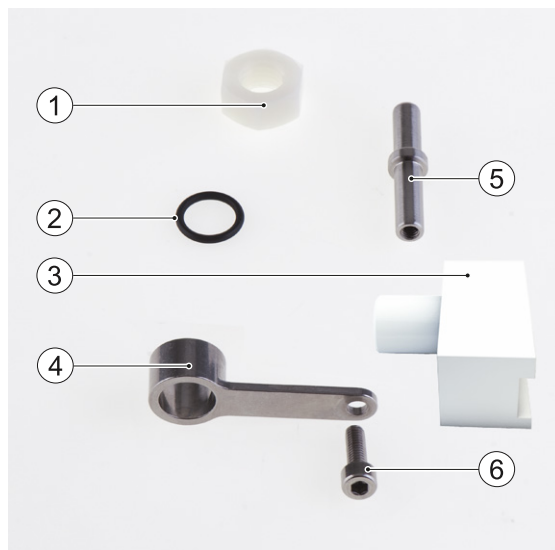

Figure 5-7: Set of 8 nozzles on the nozzle rack

The nozzle rack contains 8 nozzles (80, 120, 150, 200, 300, 450, 750 µm, and 1.0 mm). The size of the O-ring is 4.47×1.78.

5.4.1.2 Electrode



- ① Screw nut M10 (polyamide)
- ② O-Ring (10.82×1.78)
- ③ Insulator
- ④ Electrode
- ⑤ Connecting piece
- ⑥ Screw M4×12

Figure 5-8: Electrode with connecting elements

The electrode is attached with either the elongated ring showing downwards or upwards so that the distance between the nozzle and the electrode can be varied. The short distance between the nozzle and the electrode is recommended during the production of small beads and if solutions of low viscosity are used. The long distance is recommended during the production of large beads (approximately > 800 μm). The separation of the bead from the liquid jet should happen inside of the ring of the electrode, where the electrostatic field is highest, or secondarily, in the space between the electrode and the nozzle, depending on the properties of your material.

5.4.1.3 Bead bypass system

The bead bypass system is used at the beginning and end of the encapsulation run to eliminate unwanted beads produced by an unstable stream.

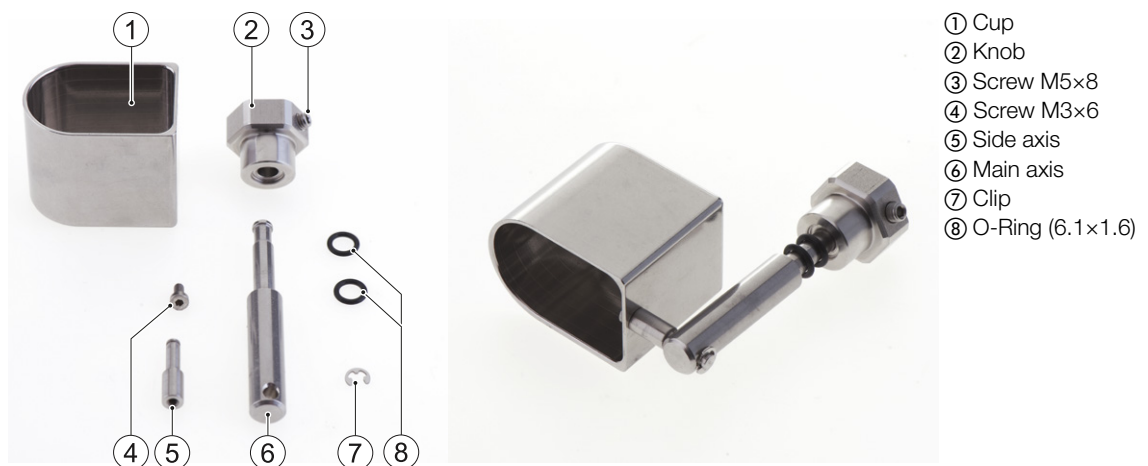

- ① Cup
- ② Knob
- ③ Screw M5×8
- ④ Screw M3×6
- ⑤ Side axis
- ⑥ Main axis
- ⑦ Clip
- ⑧ O-Ring (6.1×1.6)

Figure 5-9: Bead bypass system - exploded view (left), assembled view (right)

5.4.1.4 Air filter

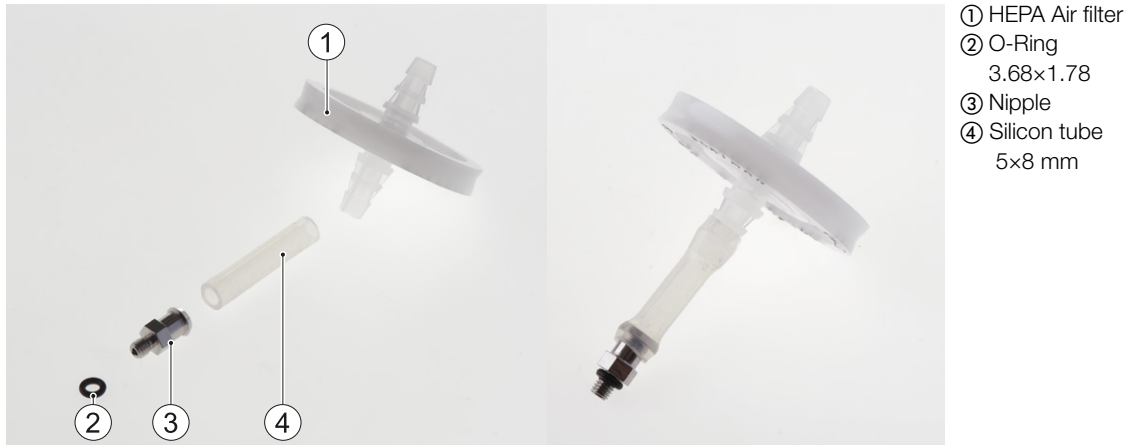

Figure 5-10: Airfilter - exploded view (left), assembled view (right)

5.4.1.5 Liquid filter



Figure 5-11: Liquid filter - exploded view (left), assembled view (right)

5.4.2 Base plate

The base plate serves a dual function with two evacuation ports. One has a filter to retain the beads in the reaction vessel while exchanging encapsulation reagents and the other is a drain valve to harvest the beads without compromising sterility.

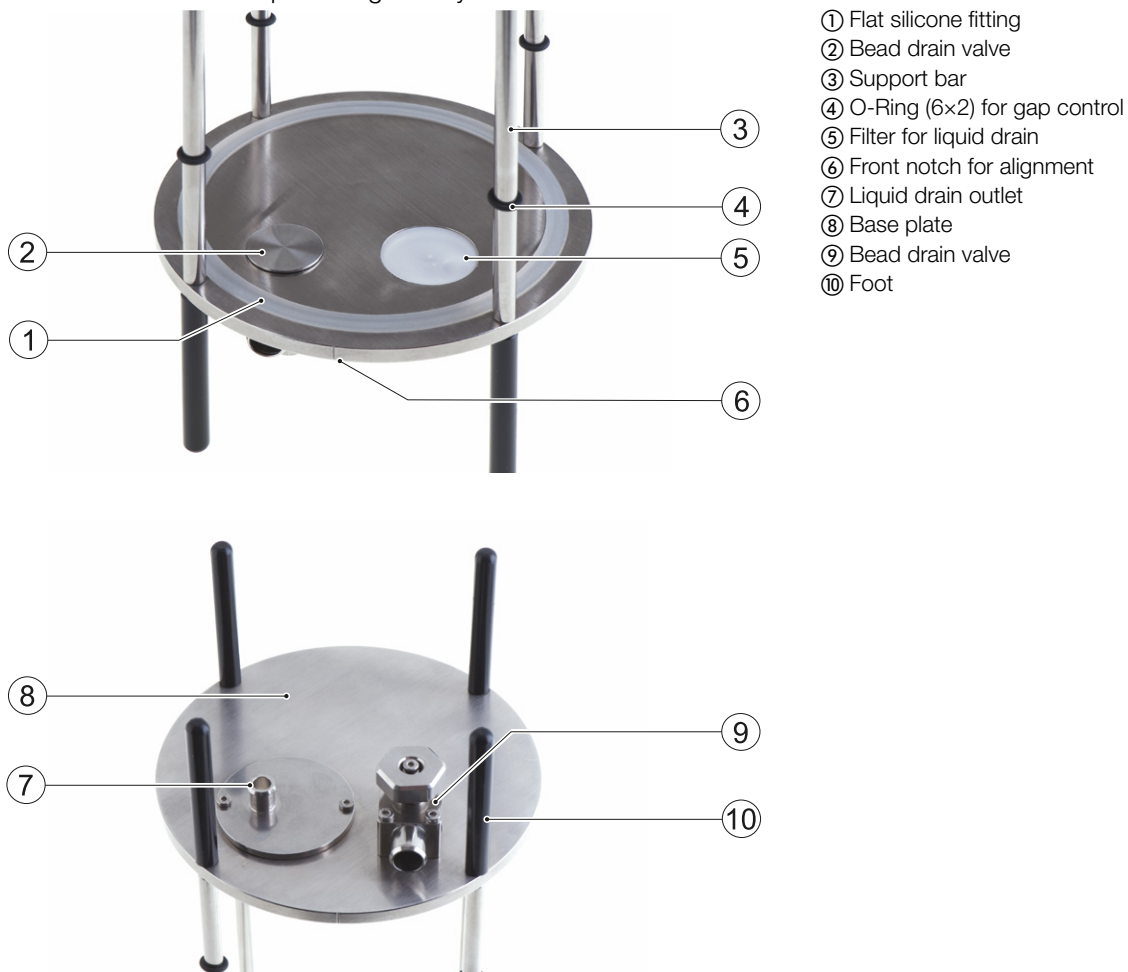
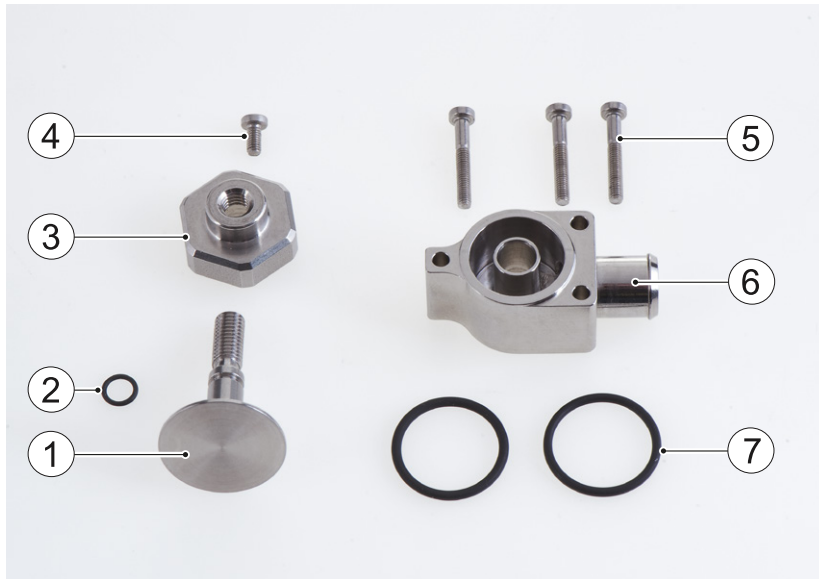

Figure 5-12: Base plate top view (above) and bottom view (below)

5.4.2.1 Bead drain valve



- ① Plunger
- ② O-Ring (5x1)
- ③ Knob for valve
- ④ Screw M3x6
- ⑤ Screw M3x20
- ⑥ Harvesting valve (BT 14)
- ⑦ O-Ring (18.77x1.78)

Figure 5-13: Parts of the bead drain valve

5.4.2.2 Liquid drain system



- ① Liquid drain plate
- ② O-Ring (34.65x1.78)
- ③ Screw M3x6
- ④ Filter grid, diameter
35 mm, 100 µm mesh

Figure 5-14: Parts of the liquid drain system

NOTE

The filter grid shrinks 1 % to 2 % during the first autoclaving. Thereafter, its dimensions remain stable.

5.4.3 Bead collecting flask

After finishing bead production and bead processing, the beads are directly transferred through the *bead harvesting valve* into the bead collecting flask. The beads can then be transported aseptically to any other container. *Figure 5-15* shows the disassembled and assembled bead collecting flask.



Figure 5-15: Bead collecting flask for sterile harvesting and transportation of the produced beads and capsules. The bead collecting flask is attached to the bead harvesting valve of the reaction vessel.

- | | |
|-----------------------------|-----------------------------|
| ① 250 mL flask | ⑤ Plate of collecting flask |
| ② Air filter, see Fig. 5-10 | ⑥ O-Ring (31.42×2.62) |
| ③ Tube clamp | ⑦ Cap with hole |
| ④ Silicone tube 10×14 | |

5.5 Pumping systems

The Encapsulator B-395 Pro provides two systems for pumping the immobilization mixture:

- by volumetric syringe pump
- by air pressure from the pressure bottles

The syringe pump is mainly used:

1. For small volumes (< 60 mL).
2. Where the liquid flow rate has to be controlled very accurately on every run.
3. When a very low dead volume is needed (approximately 0.5 mL).

Pumping with air pressure is recommended:

1. When large volumes (> 60 mL) are needed.
2. When high flow rates are to be used for producing large beads, as would be the case when using nozzles > 300 μm .

Both systems may be used with the concentric nozzle system. The core liquid is pumped with the syringe pump and the shell liquid is pumped with air pressure. Of course, you may also use two air pressure bottles by splitting the air line to the bottles with a “T” or “Y” connector.

5.5.1 Syringe pump

The syringe pump is used as a volumetric delivery system. It is a pump that very accurately delivers the immobilization mixture. Most brands of plastic syringes can be used. (The use of glass syringes is not recommended!) Each syringe type can be individually calibrated using the integrated syringe calibration system (see chapter 6 “Operation”). The availability of pre-sterilized syringes makes aseptic handling more convenient.

The pumping rate can vary from 0.01 mL/min to 50 mL/min depending on the syringe size.

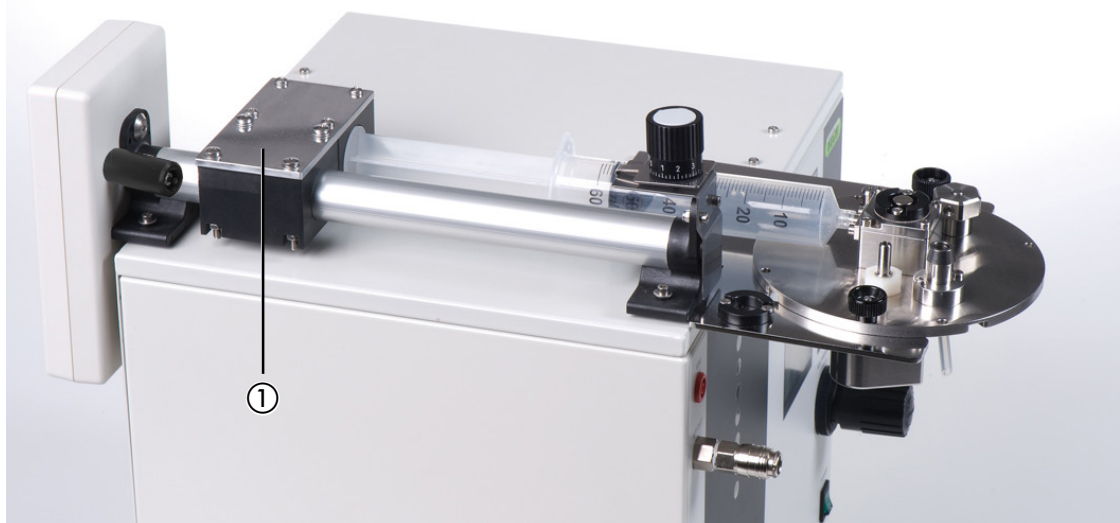

Figure 5-16: Syringe pump

The syringe is attached to the bead producing unit with the luer lock fitting. The piston of the syringe is pushed by the moving arm of the syringe pump ①.

5.5.2 Pressure bottle

The pressure bottle is an autoclavable container used to pump the immobilization mixture by air pressure. *Figure 5-17* shows the different parts of the pressure bottle.

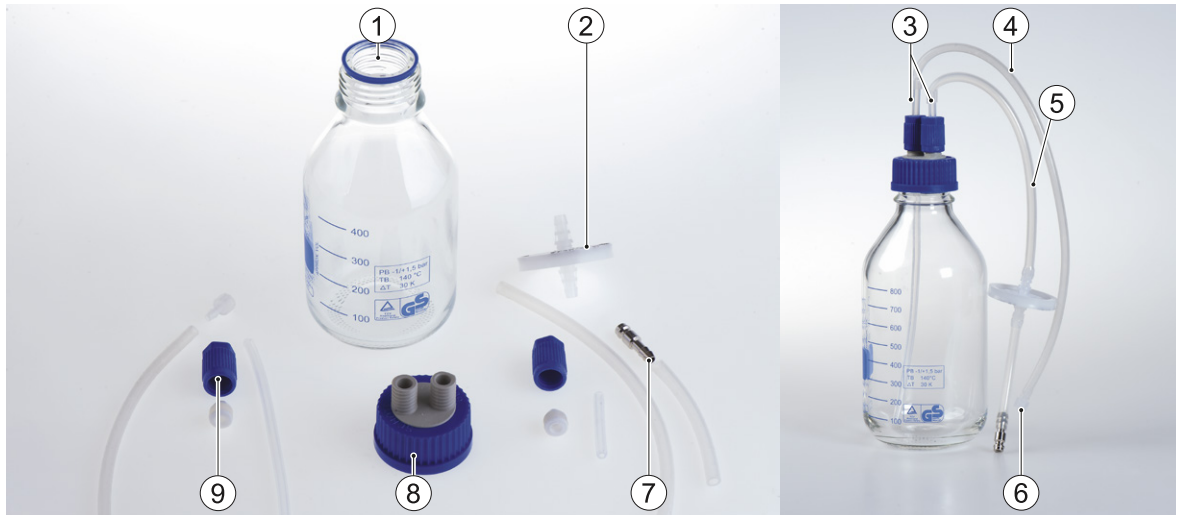

Figure 5-17: Pressure bottle with HEPA filter for sterile pumping of the immobilization mixture with air pressure

- | | |
|---|--|
| ① Pressure stable flask of 500 mL or 1,000 mL | ⑥ Luer lock male, 4.8 mm ID |
| ② HEPA air filter | ⑦ Nipple for quick coupling |
| ③ PTFE tube (4×6) | ⑧ Two port cap |
| ④ Silicone tube for liquid (4×7) | ⑨ Cap with PTFE fitting for 6 mm tubes |
| ⑤ Silicone tube for air (5×8) | |

The **air** passes through a silicone tube with an inner diameter of 5 mm (5×8 mm). The Hepa-filter prevents contamination of the sterile immobilization mixture and should be replaced according to the manufacturer's instructions or if signs of reduced air passage are noticeable.

The **liquid** passes from the inside of the bottle through a PTFE tube (3×6 mm) to the silicone tube ④ outside of the bottle. This silicone tube is attached to the bead producing unit with the luer lock male ⑥.

5.5.3 Installation of the pressure bottle



Figure 5-18: Installed pressure bottle

1. Assemble and – if needed - autoclave the pressure bottle.
2. Fill the bottle with the immobilization mixture.
3. Attach the silicone tube of the pressure bottle to the luer lock inlet of the bead producing unit.
4. Pass the silicone tube in the liquid regulating flow valve. Squeeze it so that no liquid can pass.
5. Insert the nipple of the air tube into the quick coupling of the air outlet at the control unit.

5.6 Option: Concentric nozzle system

The concentric nozzle system (CN system) is an optional kit to the single nozzle unit. It is for the production of capsules in a one-step procedure. The system consists of CN bead producing unit, a set of 7 shell nozzles (0.20, 0.30, 0.40, 0.50, 0.60, 0.70 and 0.90 mm) and one pressure bottle of 1000 mL. The shell liquid is pumped by air pressure using the pressure bottle.

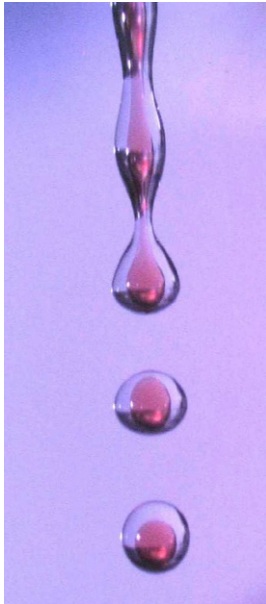

Figure 5-19: Capsule formation

The main parts of the concentric nozzle unit are (refer to *figure 5-20*):

- the nozzle pair with shell ① and core ② nozzle.
- CN bead producing unit with CN pulsation body ③ and magnet holder ④.

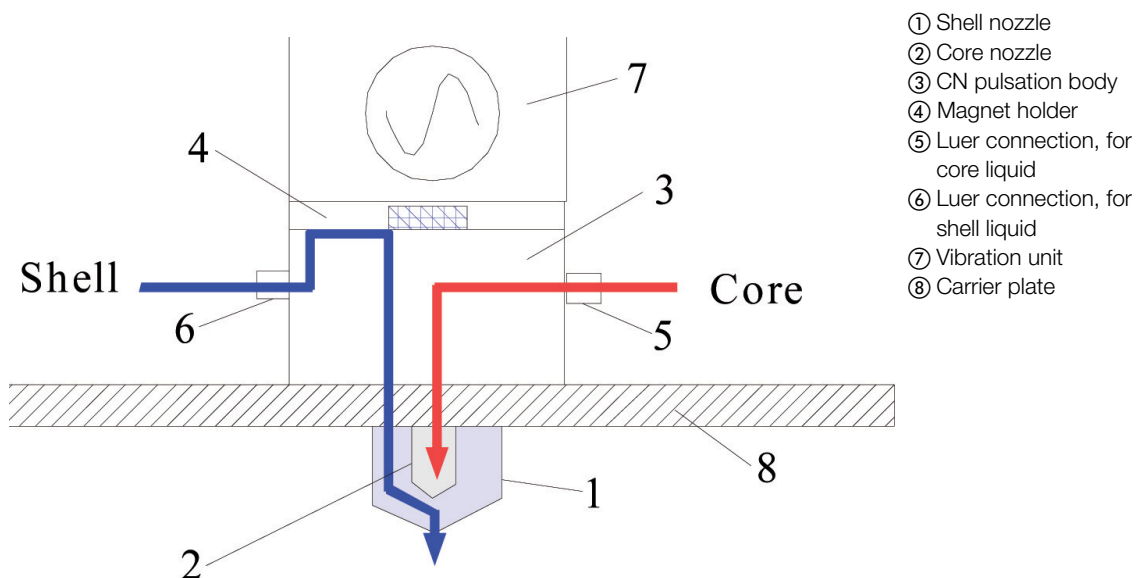

Figure 5-20: Schematic description of the concentric nozzle system



Figure 5-21: CN bead producing unit with set of 7 shell nozzles. The following nozzle apertures are standard: 0.20, 0.30, 0.4, 0.50, 0.60, 0.70 and 0.90 mm.

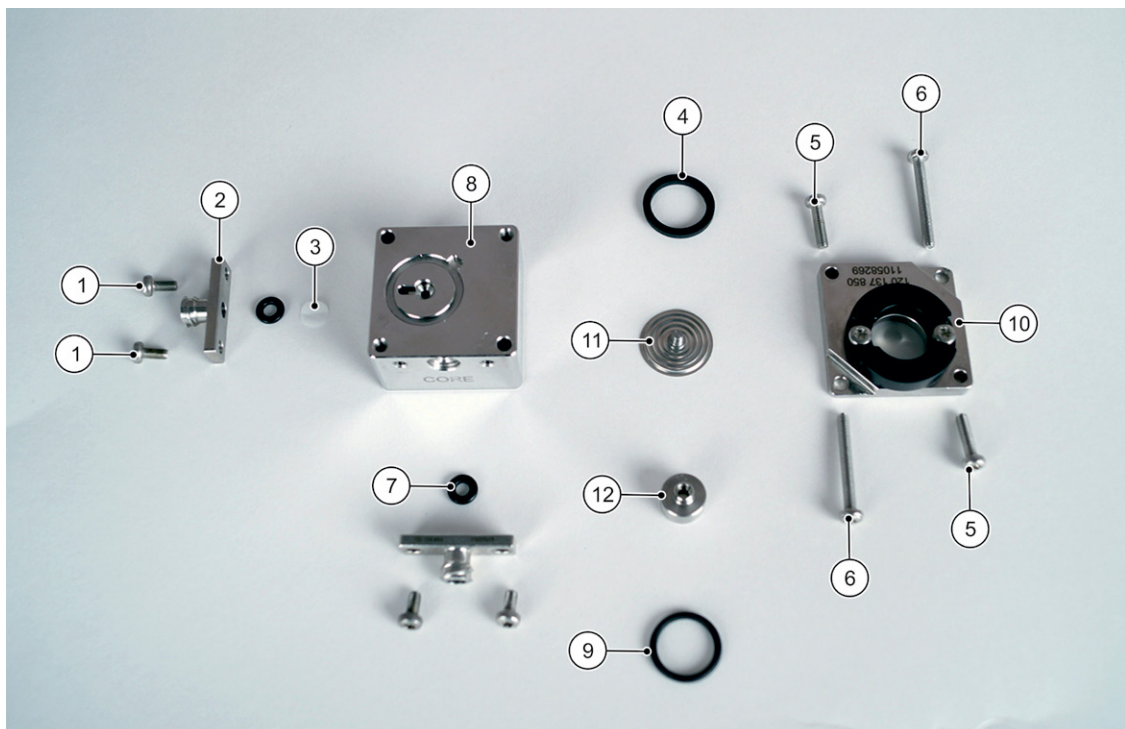
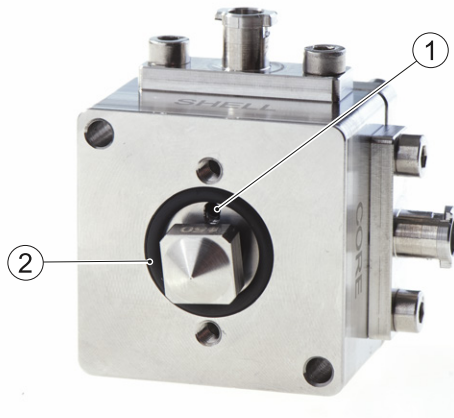

Figure 5-22: Single parts of the CN bead producing unit

- | | |
|---------------------------------------|------------------------|
| ① Screw M3×6 | ⑦ O-Ring (3.68×1.78) |
| ② Luer Lock | ⑧ CN pulsation chamber |
| ③ Pre-filter grid 50 µm mesh, D= 7 mm | ⑨ O-Ring 12.42×1.78 |
| ④ Flat gasket (18/14×1.5) | ⑩ CN magnet holder |
| ⑤ Screw M3×8 | ⑪ Membrane |
| ⑥ Screw M3×25 | ⑫ Magnet |

5.6.1 Mounting of CN nozzles



Put the O-ring 12.42×1.78 in the groove of the CN bead producing unit. Put the inner nozzle (with attached O-ring) into the hole of the CN bead producing unit. There is no thread. The inner nozzle is centered and fixed by the shell nozzle.

- ① Exit of the shell liquid
- ② O-ring 12.42×1.78

Figure 5-23: Mounting of the inner nozzle



Put carefully the shell nozzle over the inner nozzle. Attach the shell nozzle with two screws (M3×6). The shell nozzle centers and fixes the inner nozzle.

Figure 5-24: Mounting of the shell nozzle



Figure 5-25: Installation of the CN system with one syringe pump and one pressure bottle

5.7 All parts of the Encapsulator B-395 Pro



Figure 5-26: Picture of all parts of the Encapsulator B-395 Pro

5.8 Final installation check

This check has to be carried out after every installation and prior to the first encapsulation process. All connected supply media (e.g. mains voltage and gas pressure) must match the technical data of the installed system or system set-up.

- Inspect all glass components for damage.
- Check all other electrical connections for proper connection, such as optional or external components, e.g. magnetic stirrer, vibration unit, syringe pump cabling.

6 Operation

This chapter gives examples of typical instrument applications and instructions on how to operate the instrument properly and safely. See also *section 2.5 "Product safety"* for general warnings.

6.1 Starting up the instrument

- Make sure the Encapsulator B-395 Pro is properly connected to the mains supply.
- Carry out a final installation check (see *section 5.8*) before every bead production.
- Switch on the Encapsulator B-395 Pro. The system runs an internal check.

6.2 Main screens

All controlling systems for bead production are incorporated in the control unit. Vibration, pump speed, light intensity and electrostatic dispersion are controlled on two touch screens. Air pressure is regulated with the pressure regulating valve. The integrated stroboscope lamp allows real time jet breakup control.

After the internal system check the two touch screens show the following main screens:

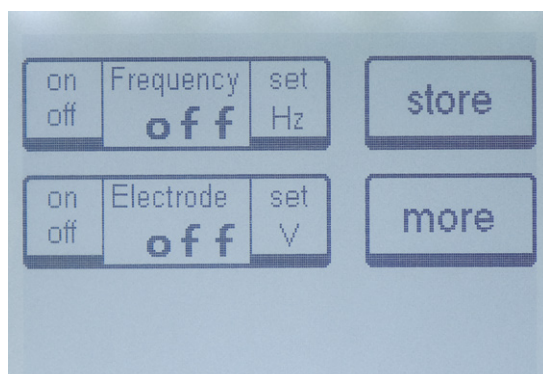

Screen 6-1: Upper touch screen

The upper touch screen is for the control of vibration frequency and electrode tension.

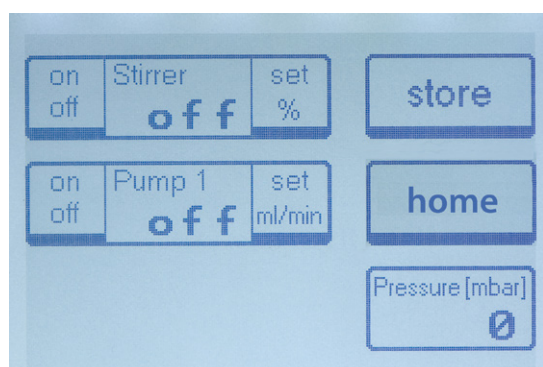

Screen 6-2: Lower touch screen

The lower touch screen is for the control of the syringe pump and the magnetic stirrer speed.

The air pressure is also indicated on this screen, however it is controlled manually through the pressure regulating valve.

NOTE

Icons with a thick bar at the bottom e.g.  activate/stop a process or lead to another screen.

6.3 Menu structure of the control unit

The figure below shows a schematic overview of all menus of the Encapsulator B-395 Pro, each with the available functionality.

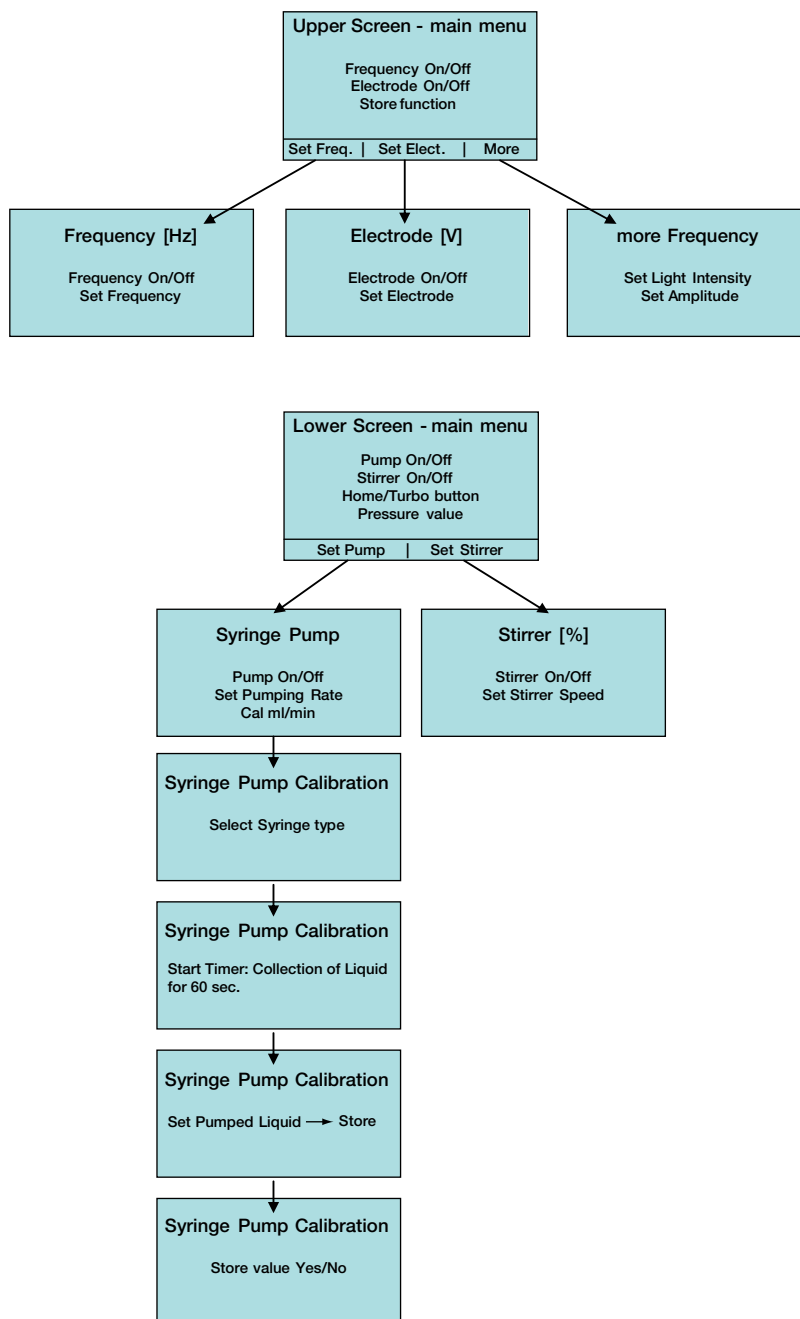
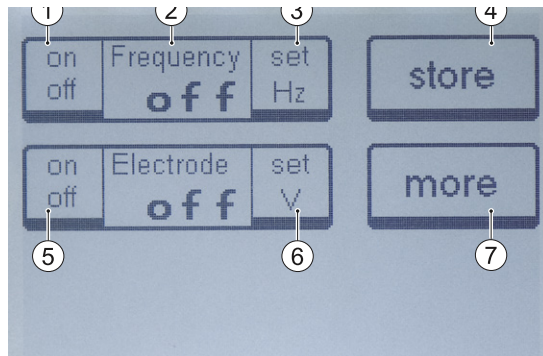

Figure 6-1: Menu structure of the control unit

6.4 Menu functions of the upper touch screen

Vibration (frequency and amplitude), electrostatic dispersion (voltage), and light intensity of the stroboscope lamp are controlled on the upper touch screen. When the Encapsulator is switched on, the touch screen runs an initialization program for few seconds. Then the screen shows the start menu (Screen 6.3) with three sub-parts (see screen 6-4 to 6-6) for frequency, electrode, and more options concerning frequency and light intensity.



- ① On/off switch for frequency control.
- ② Indication of control parameter and status of control (value or off).
- ③ Button for passing to screen 6-4 for setting frequency parameters.
- ④ Button for storing set values: press twice within one second. A sound indicates that the values are stored.
- ⑤ On/off switch for electrode control.
- ⑥ Button for passing to screen 6-5 for setting electrode parameters.
- ⑦ Button for passing to screen 6-6 for setting more frequency parameters.

Screen 6-3: Start menu of the upper touch screen

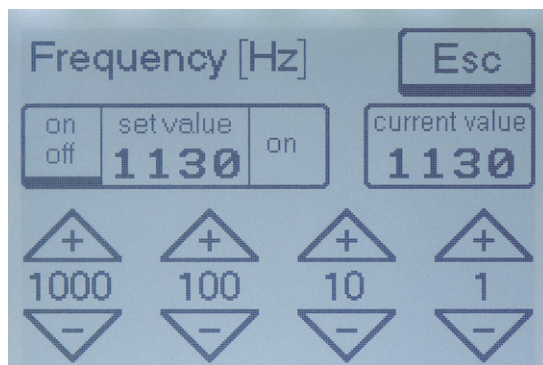

The frequency regulation generates the appropriate electric oscillation in the vibration unit. Pressing on the (+) and (-) buttons will change the frequency. Pressing the "on/off" button activates or deactivates frequency. Pressing "Esc" will return you to the start menu and the set value will be kept.

Screen 6-4: Frequency regulation

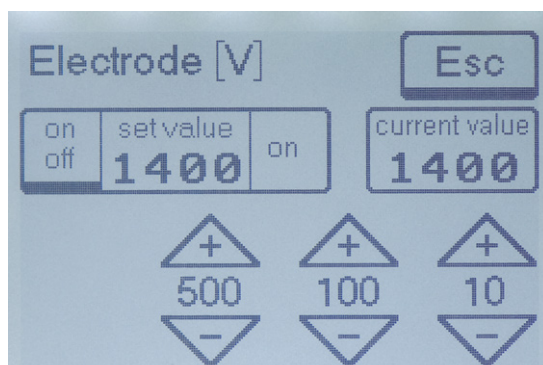

The electrostatic dispersion unit is used to charge the surface of the beads. The repulsion forces induced by the equally charged surfaces prevent the beads from hitting each other in flight, and from hitting each other as they enter the hardening solution. The applied voltage often lies in the range of 500 to 2000 V, depending primarily on the bead size and the liquid flow velocity. In this way, the Encapsulator B-395 Pro can routinely generate bead batches with homogeneity greater than 95 %. Pressing on the (+) and (-) buttons changes the electrostatic dispersion parameter. The system needs few moments to reach the set value. Pressing "Esc" will return you to the start menu and the set value will be kept.

Screen 6-5: Electrostatic dispersion unit

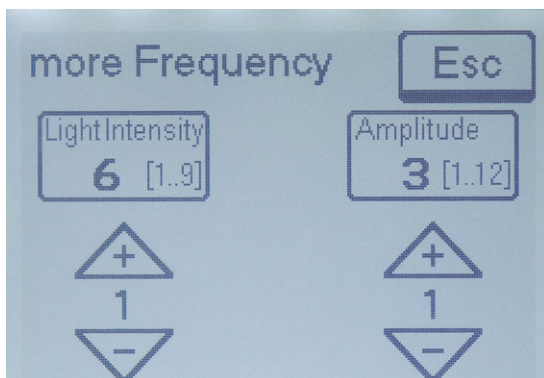

The light intensity of the stroboscope lamp and amplitude (= intensity) of the vibration can be set from 1 to 9. Above a frequency of 1500 Hz the amplitude can be set from 1 to 12. By increasing the amplitude the vibration becomes stronger. Values above 3 are mainly for solutions with viscosity > 100 mPa s. Pressing on the (+) and (-) buttons will immediately change the parameters. Pressing the "Esc"-button will cause a return to the start menu and the set value will be kept.

Screen 6-6: More options concerning amplitude of vibration and light Intensity of the stroboscope lamp.

6.5 Menu functions of the lower touch screen

Syringe pump (pump speed and calibration) and magnetic stirrer are controlled on the lower touch screen. When the Encapsulator is switched on, the touch screen runs an initialization program for few seconds. Then the screen shows the start menu with two sub-parts (see figure 6-7 to 6-10).

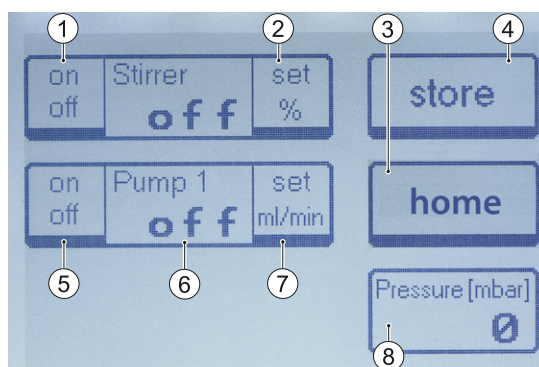

Screen 6-7: Start menu of the lower touch screen

- ① On/off switch for magnetic stirrer control.
- ② Button for passing to screen 6-9 for setting magnetic stirrer speed .
- ③ Button for sending back syringe pump arm. This button is only visible, if the arm is not already in the "home-position". When the pump is advancing, then this button becomes the "turbo"-button, see screen 6-8.
- ④ Button for storing set values: press twice within one second. A sound indicates that the values are stored.
- ⑤ On/off Switch for syringe pump control.
- ⑥ Indication of control parameter and status of control (value or off).
- ⑦ Button for passing to screen 6-10 for setting syringe pump parameters.
- ⑧ Indication of the pressure value at the air outlet from 0 to 1000 mbar.

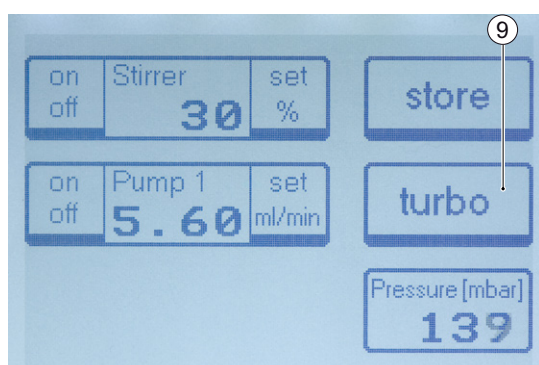

Screen 6-8: Lower touch screen with turbo button

- ⑨ Pressing the "turbo" button will double the current pumping rate.

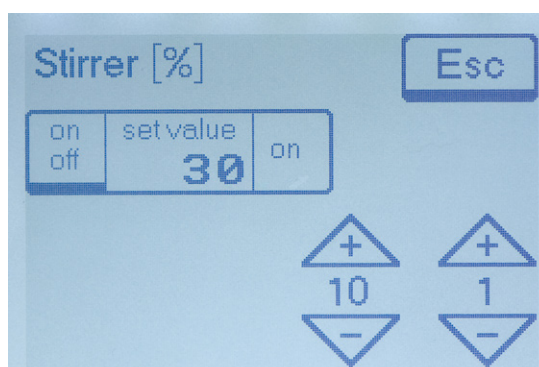

Screen 6-9: Speed regulation of the magnetic stirrer

Pressing on the (+) and (-) buttons will change the stirrer speed. Pressing "Esc" will return you to the start menu and the set value will be kept.

NOTE

The values are arbitrary values but reproducible and do not correspond to rpm.

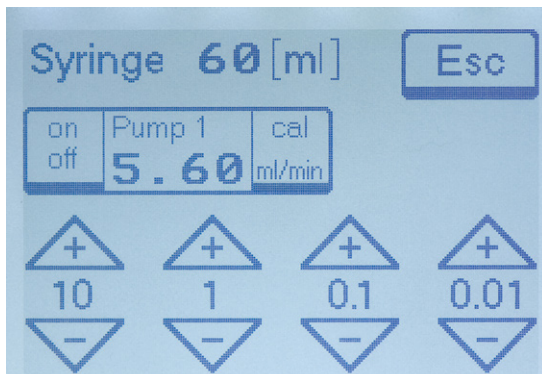

Screen 6-10: Speed regulation of the syringe pump

Pressing on the (+) and (-) buttons will change the pumping rate. Pressing “Esc” will return you to the start menu and the set value will be kept. Pressing the “cal mL/min” button, while the pump is running, will open *screen 6-11* and allows you to calibrate the current syringe. If the pump is stopped, the screen will ask you to select a calibrated syringe.

6.5.1 Menu for syringe pump calibration

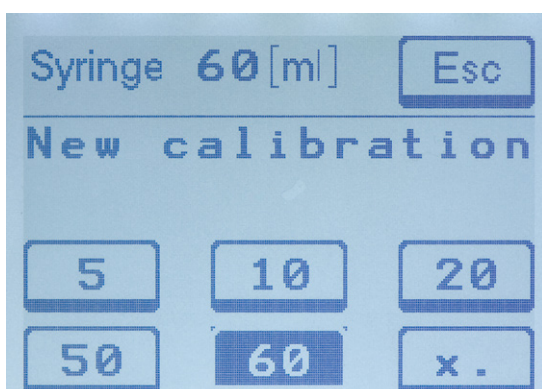

Screen 6-11: Syringe pump calibration - selecting syringe type

Select appropriate syringe volume by pressing the corresponding button. You are forwarded to *screen 6-12* (if the pump is running) or to the main screen (if the pump is stopped).

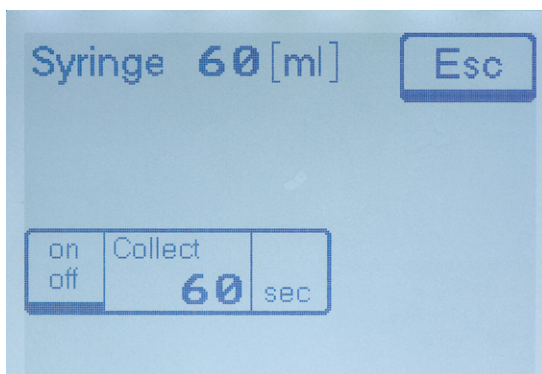

Screen 6-12: Syringe pump calibration - timer

Pressing button “on” starts timer. The timer counts down for 1 minute from 60 to 0 sec. During this time the liquid from the jet is collected in a pre-weighted vessel. The three last seconds are announced by a short tone. One second later the syringe pump stops and you are forwarded to *screen 6-13*.

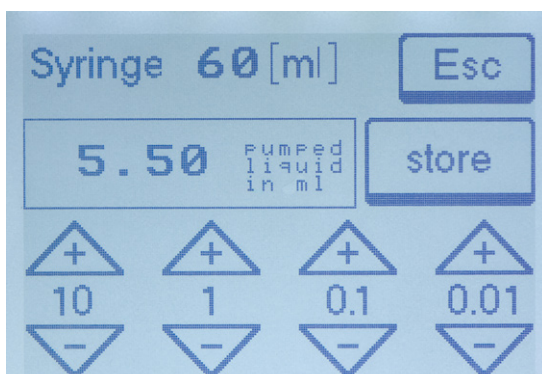

Screen 6-13: Syringe pump calibration - setting the pumped liquid

Pressing on the (+) and (-) buttons for entering the liquid pumped for 1 min. Then press button “store”. You are forwarded to *screen 6-14*.

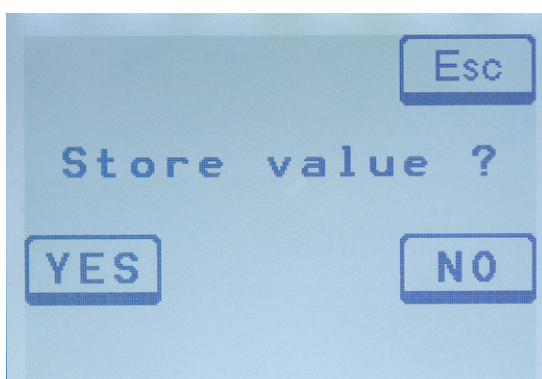

Screen 6-14: Syringe pump calibration - store value

Press “Yes” to store the values. You are forwarded to the start menu. The syringe pump will now run with the new calibration after pressing the “on” button of the pump control.

6.5.2 Selecting a calibrated syringe

Stop the pump. Press on *screen 6-10* the “cal mL/min” button. You are forwarded to *screen 6-15*.

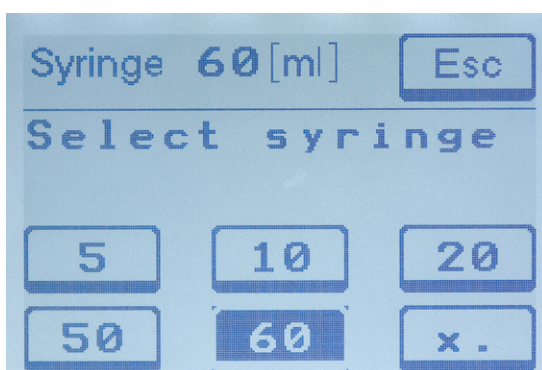

Screen 6-15: Selecting the syringe size

Select the appropriate syringe by pressing on the item. The syringe is stored and you are forwarded to the start menu.

NOTE

This screen is only accessible from the start menu, if the pump is stopped.

6.6 Manual air pressure control

In the control unit the pressure is manually controlled by the pressure regulating valve, integrated in the front panel of the control unit (see *figure 6-2*). Set the air pressure at a value which is 0.2 to 0.3 bar higher than the maximal air pressure needed during the encapsulation procedure; but not higher than 1 bar. Turning the knob of the pressure regulating valve clockwise increases the pressure, counter-clockwise decreases the pressure. The knob of the pressure regulating valve has two positions. If it is pushed in, it is locked, if it is pulled out, it is unlocked. Turning the knob counter-clockwise reduces the pressure via the self-venting system in the valve. The pressure is indicated on the touchscreen (see *screen 6-7*).

NOTE

- *The pressure of air or nitrogen entering the control unit on the rear panel of the Encapsulator should be below 7 bar (100 psi). The preferred range is between 1.5 and 2 bar (20 to 30 psi).*
- *Be aware that the pressure regulation system reacts relatively slowly, because the displacement of air in or out through the constriction valve is delayed.*
- *Do not leave the gas supply line on when the Encapsulator is not being used. The self-venting system in the valve would drain the gas tank.*
- *The maximum pressure at the air outlet is 1.5 bar (20 psi). This value is controlled by an incorporated overpressure safety valve, which opens at 1.5 bar. However the working range is from 0 to 1 bar.*



Figure 6-2: Air pressure regulating system for manual air pressure control - turning the pressure regulating valve clockwise **increases** the pressure.

6.7 Handling the syringe pump

When the syringe pump is used the first time after switching on the control unit, press the “home” button on the lower touch screen to move the pump arm back. Let the arm move completely back until it touches the end knob microswitch (see *figure 6-3*) where it stops itself. In this way, the computer of the control unit recognizes the exact position of the syringe arm. Attach the filled syringe (we recommend using plastic syringes with a luer lock system) to the bead producing unit. Let the syringe arm move forward by starting the pump (see *screen 6-10*). By pressing the “turbo” button, the arm moves at double speed. You might increase this forward speed by temporarily setting higher pumping rates. Reduce the speed as the pump arm approaches the syringe plunger. Stop the pump as the arm touches the syringe plunger. Set the desired liquid flow rate (see *screen 6-10*). Start pumping by pressing the on/off button. To prime the system, press the “turbo” button – the pump moves at double speed – until a continuous liquid jet is formed at the nozzle, then press again on the “turbo” button to move back to the preset value. If needed, adjust the pumping speed to get clearly separated beads in the light of the stroboscope.

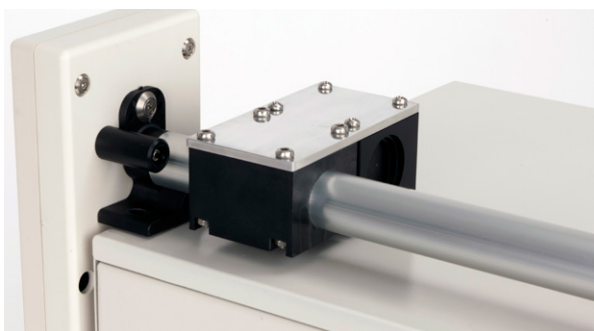

Figure 6-3: Syringe pump end knob

6.7.1 Calibrating the syringe pump

Fill the syringe with water or with the immobilization mixture and attach it to the bead producing unit. Weigh a container for collecting the liquid pumped for 1 minute and start pumping. Set the pumping rate to obtain good bead formation. Start the calibration procedure by pressing the “cal mL/min” button (see *screen 6-10*). Choose the appropriate syringe size (see *screen 6-11*).

Press the “on/off” button (see *screen 6-12*) and collect the liquid coming from the nozzle in the pre-weighed container for 60 seconds. The last three seconds are announced by a sound. One second after the last sound, the pump stops automatically. Weight the pumped liquid. Insert the value (see *screen 6-13*) and store the value. This type of syringe is now calibrated.

6.7.2 Selecting a pre-calibrated syringe

The calibrated syringe types can be recalled as needed. Stop the pump, press the “cal mL/min” button (see *screen 6-10*) and you will be forwarded to *screen 6-15*. Select the appropriate syringe and you will be forwarded to the start menu. The selection is done.

6.8 Practicing with the Encapsulator, using water

Before working with encapsulation polymers, use water for practicing with the Encapsulator to become familiar with the effects of the controls. Take the cover plate of the reaction vessel, attach the bead producing unit and a 200 μm or 300 μm nozzle to it. Place the assembled cover plate on the control unit. Attach it with the two thumb screws. Put the vibration unit on the bead producing unit. Place a large beaker (approx. 600 mL) under the nozzle. Connect the electrode with the red wire to the electrostatic dispersion unit (EDU).

6.8.1 Using the syringe pump

1. Fill a 60 mL syringe with distilled water and install it as described in *section 5.5*. Set the syringe pump speed to 4 mL/min. Activate the vibration control system and set the vibration at 1500 Hz. Activate the syringe pump. The water will flow in large drops from the nozzle. Increase the pumping speed until a continuous liquid jet is formed. Change the pumping speed and observe the bead chain in the light of the stroboscope. The proper working condition is when the beads within the bead chain are clearly separated over a length of several centimeters, 3 to 5 mm below the nozzle. Note the vibration, voltage and syringe pump settings before you stop the pump.

NOTE

If you have difficulty seeing the bead chain, reduce the amount of light around the Encapsulator and look from a distance of 20 to 30 cm (8" to 12") into the liquid jet so that the black frame of the stroboscope is directly behind the stream.

2. Start the pump again and depress the "turbo" button – the pump will move at double speed and a continuous liquid jet will be formed. Release the "turbo" button and the jet will soon stabilize at the preset flow rate. The "turbo" button is very helpful priming the system when using viscous polymer solutions and in dislodging small occlusions that impede the flow.
3. Increase the vibration frequency until the bead chain becomes unstable and then increase the pumping speed until a good bead chain is restored. Repeat this procedure in the opposite direction by decreasing the pumping speed and then decreasing the vibration frequency. After performing this exercise a few times, you will become familiar with the relationship between these two parameters. Insert the values you have determined for the optimal bead chain in *table 6-1*.

NOTE

The pumping speed and the vibration frequency influence each other within a given working range. The working range itself is mainly determined by the nozzle diameter and the viscosity of the polymer mixture.

General Rules:

- **Higher frequencies generate smaller bead sizes.**
- **Lower liquid flow rates generate smaller bead sizes.**
- **The smaller the beads the lower the electrostatic voltage needed to separate the bead stream.**
- **Smaller nozzles generate smaller bead sizes. The final bead diameter will be approximately 2 times the nozzle size.**

4. Set the pumping speed and the vibration frequency to the values you determined that creates a good, clear bead chain. Activate the electrostatic dispersion unit at 300 V and increase the voltage by steps of 100 V until the one-dimensional bead chain is transformed into a funnel-like, multi-line stream. The higher the electrostatic charge, the earlier the bead chain will separate. This prevents the beads from hitting each other in flight and from hitting each other as they enter the hardening solution since they are now like charged particles that repel each other. With this exclusive feature, the Encapsulator can routinely generate bead batches with homogeneity greater than 95 %.
5. Change the vibration frequency and the pumping speed and observe their influence on the electrostatic voltage needed to generate the bead stream separation. The use of the electrostatic dispersion unit enlarges the working range.
It can happen that after some time the beads no longer enter the receiving beaker or actually jump out of it. This is due to the fact that electrostatic charges have accumulated in the electrically isolated beaker. To avoid this phenomenon, place the supplied stainless steel clip of the grounding wire over the edge of the beaker so it extends into the receiving liquid and connect the other end of the green-yellow wire to the grounding plug on the front panel of the control unit (see figure 6-4). If you work with the complete reaction vessel, then the electrostatic charges will be automatically eliminated without the need of the grounding wire.



Figure 6-4: Grounding the open polymerization bath

6. Change the amplitude of the vibration and you will observe only slight changes in the bead chain. In general, values between 1 and 3 are optimal for low viscous solutions. If immobilization mixtures with high viscosity (> 150 mPa s) are used, values higher than 3 might be more appropriate.
7. Repeat this experiment with another nozzle size.

6.8.2 Using the pressure bottle

1. Assemble the bead producing unit, screw the 0.30 mm single nozzle to the bead producing unit and attach all on the cover plate with the screw (M3×25). Place the vibration unit on the bead producing unit. Connect the electrode with the red wire to the electrostatic dispersion unit (EDU).
2. Fill the pressure bottle with 200 to 300 mL distilled water and screw on the assembled cap. Pass the silicon tube (4×7 mm) between the blades of the flow regulating valve and attach the male luer lock fitting of the silicon tube to the female luer lock fitting of the bead producing unit. Squeeze the valve by turning the knob clock wise so that the silicon tube is closed.
3. Open the external pressurized air supply. The air inlet pressure is optimally at 1.5 to 2 bar (20 to 30 psi). However the system tolerates air inlet pressures of up to 7 bar (100 psi).
4. Set the air outlet pressure to 0.2 bar with the pressure regulating valve. Check the readout periodically to verify that the air pressure still corresponds to the set value. Activate the vibration control system and set the frequency at 800 Hz.
5. Open the flow regulating valve by turning the knob counter-clock wise until the water flows through the silicone tubing and the bead producing unit to the nozzle where it forms a continuous liquid jet. Adjust the liquid flow and/or the frequency to obtain a good bead chain in the light of the stroboscope lamp. The desired setting is when the beads within the bead chain are clearly separated for several centimeters, starting 3 to 5 mm below the nozzle. Record the position of the flow regulating valve for this desired setting.
6. Increase the vibration frequency until the bead chain becomes unstable. Then increase the liquid flow rate by slowly increasing the air pressure until a uniform bead chain is restored. Repeat this in the opposite direction by decreasing the flow rate and compensating by decreasing the vibration frequency. This may be done until you become familiar with the relationship between these two settings. Record the values in *table 6-2*.

NOTE

- *The liquid flow rate and the vibration frequency influence each other within a given working range. The working range itself is mainly determined by the nozzle diameter and the viscosity of the polymer mixture.*
- *An air pressure setting between 0.05 to 0.15 bar is sufficient to pump distilled water. **Greater working pressures indicate problems such as a clogged nozzle.***

General Rules:

- **Higher frequencies generate smaller bead sizes.**
- **Lower liquid flow rates generate smaller bead sizes.**

7. Set the liquid flow rate and the vibration frequency to a value where a clear bead chain is obtained. Activate the electrostatic dispersion unit at 300 V and increase the tension stepwise by 100 V until the one-dimensional liquid jet is transformed into a funnel-like multi-line stream. The higher the electrostatic charge the earlier the bead chain is separated. This prevents the beads from hitting each other in flight, and from hitting each other as they enter the hardening solution. Therefore the Encapsulator can routinely generate bead batches with homogeneity greater than 95 %. If nothing happens, check that the electrode is connected to the control unit.
8. Change the vibration frequency and the flow rate and observe their influence on the electrostatic tension needed to generate a jet separation. The use of electrostatic tension enlarges the working range.
It can happen that after some time, the beads no longer enter, or actually jump out of the beaker. This is due to the fact that electrostatic charges have accumulated in the electrically isolated beaker. To avoid this phenomenon, place the supplied stainless steel clip of the grounding wire over the edge of the beaker so it extends into the receiving liquid and connect the green-yellow wire to the grounding plug on the front panel of the control unit. If you work with the complete reaction vessel, then the electrostatic charges will be automatically eliminated without the need for the grounding wire.

General Rule:

The larger the beads, the higher the electrostatic voltage needed to separate the jet.

9. Change the amplitude of the vibration. You will observe only slight changes of the bead chain. Very often values between 1 and 3 are optimal for low viscous solutions. If using immobilization mixtures with rather high viscosity ($> 150 \text{ mPa s}$), values higher than 3 might be more appropriate.
10. Repeat this procedure with another nozzle size.

General Rule:

- ***Smaller nozzles generate smaller bead sizes.***
- ***The final bead diameter will be approximately 2 times the nozzle size.***

6.9 Practicing with the Encapsulator, using non-sterile alginate solution

After getting comfortable with the bead formation controls, perform test runs with non-sterile alginate solutions. Sodium alginate is the most commonly used polymer, but there are others in use with varying properties. We recommend the low viscosity grade alginate. The alginate concentration strongly influences the viscosity and this in turn influences the pressure drop in the nozzle. Therefore, the concentration of alginate solution is a function of the nozzle diameter (see the following table).

Table 6-3: Recommended alginate concentration (based on dry weight) for different nozzle diameters

Nozzle diameter	Concentration of low viscosity grade alginate	
	Working range	Recommended concentration
80 to 120 μm	0.75 to 1.4 %	1.1 to 1.2 %
120 to 200 μm	1.0 to 1.6 %	1.3 to 1.4 %
200 to 300 μm	1.2 to 1.8 %	1.5 to 1.6 %
300 to 500 μm	1.5 to 2.5 %	1.8 to 2.0 %

NOTE

Under normal storage conditions the alginate powder contains 10 - 12 % water. Therefore we refer to the alginate concentration on a dry weight base.

6.9.1 Preparation of 1.5 % Na-alginate solution

1. Take a 400 mL beaker and weigh in 3.3 g Na-alginate powder of low viscosity grade.
2. Add 200 mL of deionized water and mix vigorously with a laboratory mixer for 1 to 2 minutes.
3. Alginate has the tendency to get lumpy. Remove the alginate lumps from the beaker and the mixer blades with a spatula and mix again for 1 to 2 minutes. If lumps remain in the liquid, repeat mixing.
4. Then let the mixture stand so that the trapped air bubbles will escape from the liquid.
5. If needed, de-gas the mixture under reduced pressure.
6. Dissolution of alginate with a magnetic stirrer takes much more time and should be done overnight.

NOTE

Alginate solutions will support the growth of microorganisms and are stable for about 2 weeks in a refrigerator. An indication of microbial contamination is reduction of the mixture's viscosity. Alginate solutions can be stored for much longer time, even at room temperature, if sterilized or if preservatives are added, like 0.05 % NaN_3 .

6.9.2 Working with the syringe pump

1. Attach a 200 μm or 300 μm nozzle to the bead producing unit. Place the assembled cover plate on the control unit. Attach it with the two thumb screws. Put the vibration unit on the bead producing unit. Connect the electrode with the red wire to the electrostatic dispersion unit (EDU). Put the magnetic stirrer below the nozzle and a large beaker on the stirrer. Fill the beaker with 100 mM CaCl_2 so that at least 2 cm (approx. $\frac{3}{4}$ ") is filled with the polymerization liquid. Put a magnetic stir bar in the beaker and adjust the stirrer, so that a slight vortex is visible. A vortex in the liquid will create shear forces which may deform the beads. It is best to use a stir bar without a spin ring (supplied) because the spin ring will raise up the stir bar and may crush the beads beneath it. Also, place the grounded clip over the edge of the beaker and into the liquid. At this time, either cover the beaker with a plate (petri dish) or move it and the stirrer out of the way and position another beaker with water in it (and the grounding clip) under the nozzle in its place.
2. Fill a 60 mL syringe with the above 1.5 % alginate solution and install it on the Encapsulator.
3. Activate the vibration control system and set the vibration frequency at 1200 Hz for the 200 μm nozzle or at 900 Hz for the 300 μm nozzle. Activate the syringe pump and set the pumping speed to 5 mL/min for the 200 μm nozzle or 8 mL/min for the 300 μm nozzle. Depress the "turbo" button until a continuous liquid jet is formed. Release the "turbo" button and the jet will soon stabilize at the preset flow rate. Adjust the pumping speed and/or the frequency to obtain a clear bead chain below the electrode.
4. Activate the electrostatic dispersion unit at 500 V. Increase the voltage by steps of 100 V to get a circular dispersal of the bead stream 3 to 10 cm (1" to 4") after the electrode. An optimal distance is about 5 cm (approximately 2") below the electrode. If nothing happens, verify that the electrode is connected to the control unit.

NOTE

The stronger the circular dispersal of the bead stream, the better is the bead homogeneity. This does not only depend on the electrostatic tension, but the liquid flow rate and the vibration frequency are also factors. They influence the way that the bead is separated from the liquid jet within the electrostatic field between the nozzle and the end of the electrode. Smaller beads are often separated from the liquid jet nearer to the nozzle than larger beads.

5. As soon as a symmetrical and stable dispersal pattern is obtained, exchange the beaker with the beaker containing polymerization solution. Collect the beads for about 1 minute. Record the process parameters in *table 6-4* while the beads are accumulating. Cover the beaker (or exchange it with the previous beaker containing waste) and stop the bead production by turning off the syringe pump, vibration control and electrostatic voltage.

NOTE

Clean the nozzle thoroughly immediately after each run with distilled water to avoid nozzle clogging or partial occlusion due to dried out polymer mixture.

Table 6-4: Encapsulator trial test work sheet (syringe pump)

Syringe size [mL]					
Nozzle size [μm]					
Alginate concentr. [%]					
Pumping speed [mL/min]					
Vibration frequency [Hz]					
Amplitude					
Approximate bead size [μm]					
Homogeneity [%]					
Comments					

- Inspect the beads under a microscope with a micrometer scale eyepiece and record your observations of diameter, uniformity and shape in *table 6-4*.
- Repeat this procedure for each change in process parameters.

NOTE

When producing small beads with a diameter $<500 \mu\text{m}$, it may occur that their shape is not spherical but somewhat oval. This is mainly due to the surface tension of the polymerization solution. A very critical point for the bead is its entrance into the polymerization solution. If the surface tension is high, then the bead is partially held back at the surface and polymerization starts before the bead can regain a round shape. This problem can be eliminated by adding a small quantity of surfactant like Tween 20 to the polymerization mixture.

- Compare the influence of the electrostatic dispersion unit by collecting beads at the same vibration frequency and pumping rate with and without the electrostatic function turned on.
- Determine the working field by stepwise changing the pumping speed from the lowest liquid flow rate which just creates a continuous liquid jet up to a flow rate where a clear bead chain is no longer visible at any vibration frequency. Note the corresponding lowest and highest frequencies in *table 6-5*.

Table 6-5: Determination of the working field

Pumping speed [mL/min]	Clear bead chain without electrostatic tension		Clear bead chain with electrostatic tension		
	Lowest frequency	Highest frequency	Electrostatic tension	Lowest frequency	Highest frequency

Pumping speed [mL/min]	Clear bead chain without electrostatic tension		Clear bead chain with electrostatic tension		
	Lowest frequency	Highest frequency	Electrostatic tension	Lowest frequency	Highest frequency

6.9.3 Working with the pressure bottle

1. Attach a 200 μm or 300 μm nozzle to the bead producing unit. Place the assembled cover plate on the control unit. Attach it with the two thumb screws. Put the vibration unit on the bead producing unit. Connect the electrode with the red wire to the electrostatic dispersion unit (EDU). Put the magnetic stirrer below the nozzle and a large beaker on the stirrer. Fill the beaker with 100 mM CaCl_2 so that at least 2 cm (approx. $\frac{3}{4}$ ") is filled with the polymerization liquid. Put a magnetic stir bar in the beaker and adjust the stirrer, so that slight vortex is visible. Also, place the grounded clip over the edge of the beaker and into the liquid. At this time, either cover the beaker with a plate (petri dish) or move it and the stirrer out of the way and position another beaker with water in it (and the grounding clip) under the nozzle in its place.
2. Fill the pressure bottle with the above described 1.5 % alginate solution and screw on the assembled cap. Pass the silicon tube (4x7 mm) between the blades of the liquid flow regulating valve and attach the male luer lock fitting of the silicon tube to the female Luer lock fitting of the bead producing unit. Squeeze the valve by turning the knob clock wise so that the silicon tube is closed.
3. Open the external pressurized air supply. The air inlet pressure is optimally at 1.5 to 2 bar (20 to 30 psi). However the system tolerates air inlet pressures of up to 7 bar (100 psi).
4. Set the air pressure to 0.4 bar at the pressure regulation system. Check the readout periodically to verify that the air pressure still corresponds to the set value. Activate the vibration control system and set the vibration frequency at 1100 Hz for the 200 μm nozzle and at 800 Hz for the 300 μm nozzle.
5. Open the flow regulating valve by turning the knob counter-clock wise until the liquid flows through the silicone tubing and the bead producing unit to the nozzle where it forms a continuous liquid jet. Adjust the liquid flow and/or the frequency to obtain a good bead chain in the light of the stroboscope lamp. The desired setting is when the beads within the bead chain are clearly separated for several centimetres, starting 3 to 5 mm below the nozzle. Record the position of the flow regulating valve for this desired setting.
6. Increase the vibration frequency until the bead chain becomes unstable. Then increase the liquid flow rate by slowly increasing the air pressure or by slowly opening the flow regulating valve until a uniform bead chain is restored. Repeat this in the opposite direction by decreasing the flow rate and compensating by decreasing the vibration frequency. This may be done until you become familiar with the relationship between these two settings. Record the values in *table 6-5*.

NOTE

An air pressure setting from 0.1 to 0.8 bar is generally sufficient to pump the polymer mixture.

Working pressures greater than 1.0 bar should be avoided and are indicative of problems such as:

- *Clogged nozzle,*
 - *Overly viscous polymer mixture,*
 - *Under sized nozzle for the polymer mixture in use.*
7. Activate the electrostatic dispersion unit at 500 V. Increase the voltage by steps of 100 V to get a circular dispersal of the bead stream 3 to 10 cm (1" to 4") after the electrode. An optimal distance is about 5 cm (approx. 2") below the electrode.

NOTE

The stronger the circular dispersal of the bead stream the better is the bead homogeneity. This does not only depend on the electrostatic tension, but the liquid flow rate and the vibration frequency are also factors. Ideally, the bead should separate from the liquid jet within the electrostatic field between the nozzle and the end of the electrode.

- As soon as a symmetrical and stable dispersal is obtained, remove the plate from the beaker filled with polymerization solution or replace the beaker of water with the beaker of polymerization solution and the stir plate (and the grounding forceps), and collect the beads for about 1 minute. Record the process parameters in *table 6-5* while the beads are accumulating. Cover or switch the beaker and stop the bead production by turning off the electrostatic voltage, air pressure control and vibration control.

NOTE

Clean the nozzle thoroughly immediately after each run with distilled water to avoid nozzle clogging or partial occlusion due to dried out polymer mixture.

- Check the beads under a microscope with a micrometer scale eyepiece, and record your observations of diameter, uniformity and shape in *table 6-6*.
- Repeat this process for each change in process parameters.

Table 6-6: Encapsulator trial test work sheet (pressure bottle)

Nozzle size [μm]					
Alginate concentr. [%]					
Position of the flow regulating valve					
Vibration frequency [Hz]					
Amplitude					
Approximate bead size [μm]					
Homogeneity [%]					
Comments					

NOTE

When producing small beads with a diameter $<500 \mu\text{m}$, it may occur that their shape is not spherical but somewhat oval. This is mainly due to the surface tension of the polymerization solution. A very critical point for the bead is its entrance into the polymerization solution. If the surface tension is high, then the bead is partially held back at the surface and polymerization starts before the bead can regain a round shape. This problem can be eliminated by adding a small quantity of surfactant like Tween 20 to the polymerization mixture.

- Compare the influence of the electrostatic tension by collecting beads at the same vibration frequency and pumping rate with and without the electrostatic tension function turned on.

6.10 Practicing with the Encapsulator, working with the complete reaction vessel

After getting comfortable with Ca-alginate bead formation, perform test runs with the complete reaction vessel to simulate sterile working conditions, but by using non-sterile alginate solution. Sterile working conditions have the additional difficulty that it is often impossible to modify something in the autoclaved reaction vessel without losing sterility, like if a piece was forgotten or assembled in the wrong way. Therefore, it is important that the reaction vessel is properly prepared before sterilization. Follow *section 5* for the assembly and sterilization of the reaction vessel. If you change something, note it in a separate procedure.

1. Prepare all the needed encapsulation reagents (as an example, for animal cell encapsulation, see *section 6.14*).

For this run:	60 mL	1.5 % alginate solution
	500 mL	100 mM CaCl ₂ polymerization solution
	600 mL	0.9 % NaCl + 10 mM CaCl ₂ washing solution

Assemble a pressure bottle.

2. Take the autoclaved reaction vessel and attach it to the control unit. Verify that the silicone tubing at the liquid drain port of the reactor base plate is closed with a clamp. Make sure that the bead collecting valve at the reactor vessel is closed, that the magnetic stirrer is below the reactor and that the stirrer bar is above the magnetic stirrer.
 - Connect the electrostatic dispersion unit with the red wire to the reaction vessel.
 - Move the collection cup of the bead bypass below the nozzle.
3. Place 500 mL of polymerization solution in the pressure bottle. Attach the silicone tubing to the liquid membrane filter. Connect the pressure bottle to the air outlet of the control unit. Switch on the control unit. Set the air pressure at 0.3 to 0.7 bar (4 to 10 psi). When the desired amount of liquid is pumped, release the air pressure.

NOTE

The amount of hardening solution should be 8 to 10 times the volume of the polymer mixture. The polymerization solution should have a height of at least 2 cm (approx. 3/4") in the reaction vessel (a minimum of 200 mL).

4. Set the vibration frequency, the electrostatic tension and – if the syringe pump is used – the pumping rate to the appropriate values as previously determined. Set the speed of the magnetic stirrer so that a vortex is just visible.
5. Fill a 60 mL syringe with the alginate/sample solution and attach it to the Encapsulator. Activate the vibration control system and set the vibration frequency at values predetermined in *section 6-9*. Activate the syringe pump and set the pumping speed as previously determined. Press the “turbo” button until a continuous liquid jet is formed. Activate the electrostatic dispersion system. If needed, adjust the pumping speed and/or the frequency to obtain a clear bead chain down to the collection cup.

6. As soon as the bead chain is stable, move the collection cup out of the way of the liquid jet to start the actual bead production process. The bead stream should disperse 3 to 10 cm (approximately 1" to 4") below the electrode. An optimal distance is about 5 cm (2") below the electrode. To achieve this goal you will need to adjust the electrostatic tension and possibly slightly fine tune the vibration frequency and pumping speed.
7. Note and record the exact process parameters. Inspect the actual bead production in the light of the stroboscope lamp to verify the settings.
8. Shortly before the syringe plunger is fully depressed, move the collection cup of the bypass back into the bead stream. This will prevent that large droplets, which are formed at the end of the production process, contaminate the homogeneous collection. Stop the pump. Turn off the electrostatic dispersion unit and the vibration control system. Or press "home" to move back the arm of the syringe pump. This will also deactivate the electrostatic dispersion unit and the vibration.
9. Let the beads harden for 5 minutes.
10. To drain the hardening solution from the reaction vessel, slowly open the drain clamp so that it will take 1 to 2 minutes to drain 500 mL. Turn off the magnetic stirrer when about $\frac{3}{4}$ of the liquid has drained. Close the drain clamp as soon as the liquid level reaches the settled beads.

NOTE

Always leave the beads slightly covered with solution to prevent clumping.

11. Fill the bottle of the liquid transfer set with 400 mL of washing solution and pump it into the reaction vessel. Restart the magnetic stirrer as soon as the magnetic stir bar is covered with liquid so the beads are not damaged. Wash the beads for 5 minutes and then drain off the liquid as described above (item 10).
12. Pump in the final 200 mL of washing solution into the reaction vessel. Re-suspend the beads by turning on the magnetic stirrer.
13. Open the bead collecting valve and let the beads flow into the bead collecting flask. If beads remain in the reaction vessel, let liquid flow back from the bead collecting flask into the reaction vessel by raising the bead collecting flask higher than the reaction vessel drain. Re-suspend the remaining beads with this liquid and transfer it back into the bead collecting flask by lowering it below the reaction vessel.
14. Close the silicone tube from the reaction vessel to the bead collecting flask with the clamp. Disconnect the bead collecting flask from the reaction vessel and check the beads for quality under a microscope.
15. Immediately after the end of the bead production process fill a syringe with distilled water, attach it to the bead producing unit and flush the nozzle to avoid having the polymer dry and clogging the system thus creating a maintenance problem. Clean the reaction vessel thoroughly, including the various in and out ports.

6.11 Heat sterilization of the reaction vessel

1. Prepare the Reaction Vessel according to section 5.4.
2. Add 2 to 5 mL of water into the reaction vessel.
3. Verify that the following items are connected or prepared correctly:
 - The proper sized nozzle
 - The electrode centered below the nozzle
 - Does the luer lock plug close the bead producing unit?
 - Are the air and liquid filters attached?
 - Is a magnetic stirrer bar in the reaction vessel?
 - Is the bead collecting flask attached?
 - Is the passage from the reaction vessel to the bead collecting flask open (open bead drain valve)?
 - Is the drain tubing closed with a clamp?
 - Is the luer lock of the bead producing unit closed with a luer lock stopper?
4. Put the assembled reaction vessel in the autoclave and steam sterilize at 121°C for 20 minutes or according to your protocol.
5. After autoclaving, remove the hot reaction vessel from the autoclave as soon as possible to avoid water condensation in the air filter. Because a completely wetted air filter will no longer let air pass, it will be difficult to drain the liquids from the reaction vessel, due to the negative pressure created in the reaction vessel. To test the air filter's condition, attach a 60 mL syringe to the filter. When moving the syringe piston back and forth, only a slight resistance should be felt.
6. Close the bead collecting valve only after the reaction vessel has cooled down to room temperature.

6.12 Sterilization of the pressure bottle

1. Assemble the pressure bottle and close the luer lock fitting with a luer lock stopper.
2. Add 1 to 2 mL of water into the pressure bottle. Place the assembled pressure bottle in the autoclave and steam sterilize at 121°C for 20 minutes or according to your protocol.

6.13 Encapsulation procedure for immobilization of micro-organisms in Ca-alginate beads

In this section, a simple but well established method is described for the immobilization of microorganisms in Ca-alginate beads. The stability of these beads depends not only on the alginate type used, but on the future culture conditions. The Ca ions in the hardening solution substitute for the Na ions in the droplets causing the alginate beads to harden (this is a reversible reaction). If more resistant beads are required, because some culture media have ingredients that will slowly dissolve the beads, Ca ions may be replaced by Ba ions, which have a stronger affinity to alginate than Ca ions and the resultant Ba-alginate beads will be more stable.

Sterilization of alginate solutions is best accomplished by sterile membrane filtration (0.2 μm). Heat sterilization tends to partially degrade the alginate and unpredictably changes the viscosity and the polymerization capacity.

For the encapsulation of animal cells, it is recommended to use another protocol because the three dimensional structure of the Ca-alginate hinders the formation of the new cell membrane during cell division. For dividing cells, capsules are better suited. A procedure for the production of alginate-PLL capsules is described in *section 6-14*.

1. Prepare all needed materials as described in *section 6-10*; reaction vessel, pressure bottle, 60 mL syringe, beakers, graduated cylinders, etc. Autoclave the reaction vessel.
2. Prepare all needed encapsulation reagents.

For this run:	50 mL	1.5 % alginate solution, low viscosity grade, sterile filtered
	500 mL	100 mM CaCl_2 polymerization solution (non-sterile)
	600 mL	0.9 % NaCl + 10 mM CaCl_2 washing solution (non-sterile)

3. Switch on the control unit. Set the vibration frequency, the electrostatic tension and the pumping rate to the appropriate values as previously determined.
4. Place 500 mL of polymerization solution in the pressure bottle and close it. Attach the silicone tubing to the liquid membrane filter. Pump the polymerization solution into the reaction vessel.
5. Detach the silicone tubing from the membrane filter and place the reaction vessel in a sterile biological hood.
6. Prepare 10 mL of concentrated microorganism suspension. The suspension should be free of bi- or trivalent cations (e.g. Ca, Mg, Al, Fe) or contain them in a very low concentration, to avoid preliminary polymerization reactions with the alginate. Choose the desired microorganism concentration the way that it is in the final polymer mixture < 10¹⁰ cells/mL (for animal cells <10⁷ cells/mL). Carefully mix the 10 mL microorganism suspension with 50 mL 1.5 % sterile alginate solution gently to minimize the formation of air bubbles.
7. Fill a sterile 60 mL syringe with the polymer-product mixture aseptically. Attach the syringe to the bead producing unit. Attach the reaction vessel (with the attached syringe) to the control unit. Advance the syringe pump arm, so that it touches the plunger. Start the magnetic stirrer so that a slight vortex is visible. Activate the vibration and the syringe pump. Press the "turbo" button until a continuous liquid jet is formed. Activate the electrostatic dispersion unit. If needed, modify the pumping speed or/and the frequency to obtain a clear bead chain down to the collection cup.

8. As soon as the bead chain is stable, move the collection cup out of the way of the liquid jet to start the actual bead production process. Verify that the bead stream is dispersed 3 to 10 cm (approximately 1" to 4") below the electrode. An optimal distance is about 5 cm (2") below the electrode. Adjust the electrostatic voltage to achieve this goal.
9. Record the exact process parameters while monitoring the bead production.
10. Shortly before the syringe plunger is fully depressed, move the collection cup back into the bead stream. Stop the pump.
Turn off the electrostatic dispersion unit and the vibration control system.
11. Let the beads harden for 5 minutes.
12. To drain the hardening solution from the reaction vessel, slowly open the drain clamp so that it will take 1 to 2 minutes to drain 500 mL. Turn off the magnetic stirrer when about $\frac{3}{4}$ of the liquid has drained. Close the drain clamp as soon as the liquid level reaches the settled beads.

NOTE

Always leave the beads slightly covered with solution to prevent clumping.

13. Fill the pressure bottle with 400 mL of washing solution and pump it into the reaction vessel.
Restart the magnetic stirrer as soon as the magnetic stir bar is covered with liquid so the beads are not damaged. Wash the beads for 5 minutes and then drain off the liquid as described above (item 12).
14. Pump the final 200 mL of washing solution into the reaction vessel. Re-suspend the beads by turning on the magnetic stirrer.
15. Open the bead collecting valve and let the beads flow into the bead collecting flask.
16. Close the silicone tube from the reaction vessel to the bead collecting flask with the clamp.
Disconnect the bead collecting flask from the reaction vessel and check the beads for quality under a microscope.
17. Immediately after the end of the bead production process fill a syringe with distilled water, attach it to the bead producing unit and flush the nozzle to avoid having the polymer dry and clogging the system thus creating a maintenance problem. Clean the reaction vessel.

6.14 Encapsulation protocol for alginate-PLL-alginate membranes

The Alginate-Polylysine-Alginate-membrane is a well established encapsulation system for animal cells first described by Lim and Sun¹. Below is a well tried protocol.

Required solutions

1. 1.5 % Alginate solution: 1.5 % low viscosity alginate in MOPS washing-buffer
adjust pH to 7.0 at 25°C
sterile filtration through a 0.2 µm filter
2. Polymerization solution: 10 mM MOPS (Morpholinopropanesulfonic acid)
100 mM CaCl₂
pH = 7.2 at 25°C
3. PLL solution: 0.05 % Poly-L-lysine MG 15'000-30'000 in MOPS washing buffer
4. MOPS washing buffer: 10 mM MOPS (Morpholinopropanesulfonic acid)
0.85 % NaCl
pH = 7.2 at 25°C
5. 0.03 % alginate solution: 2 mL of 1.5 % alginate solution.
+ 98 mL MOPS washing-buffer.
6. Depolymerization solution: 50 mM Na₃-Citrate
0.45 % NaCl
10 mM MOPS
pH = 7.2 at 25°C

For one encapsulation of 12 mL polymer-product mixture the following is needed:

- 12 mL 1.5 % alginate solution (sterile filtered)
- 100 mL 0.03 % alginate solution (not sterile)
- 225 mL Polymerization solution (not sterile)
- 75 mL PLL Solution (not sterile)
- 900 mL MOPS Washing buffer (not sterile)
- 200 mL Depolymerization solution (not sterile)

¹Lim F. and Sun A.M. 1980. Microencapsulated Islets as Bioartificial Pancreas. Science 210: p.908-910.

Procedure

1. Prepare the reaction vessel and autoclave it as described in section 6.10 and 6.11.
2. Prepare all solutions and labware.
3. Fill the autoclaved reaction vessel with 225 mL polymerization solution.
4. A cell culture with ca. 6×10^6 cells (or according to personal need) is centrifuged and the pellet is re-suspended in 2 mL sterile MOPS washing buffer and mixed with 10 mL 1.5 % sodium-alginate solution. Give care, that no or only few air bubbles are introduced during mixing.
5. Fill a 20 mL syringe with the cell-alginate suspension and attach the syringe to the reaction vessel in a laminar air hood.
6. Fix the reaction vessel to the Encapsulator control unit, which is placed on the bench.
7. Start bead formation with previously established parameters.
8. Allow for bead hardening for 5 minutes, then stop stirrer and drain off polymerization solution.

NOTE

The beads and later the capsules should always be covered by a small amount of liquid to prevent clumping, otherwise re-suspension of the beads and capsules would become difficult and the membrane might be damaged.

9. Pump in 75 mL 0.05 % PLL solution and let form the PLL-alginate membrane for 10 minutes.
10. Drain of the 0.05 % PLL-solution.
11. Pump in 150 mL MOPS washing buffer, stir for 1 min and then drain off.
12. Pump in another 150 mL MOPS washing buffer, stir for 5 min and then drain off the buffer.
13. Pump in 100 mL 0.03 % alginate solution and allow 5 minutes stirring for the formation of the outer alginate membrane, then drain off the alginate solution.
14. Pump in 150 mL MOPS washing buffer, stir for 1 min and then drain off the buffer.
15. Pump in 150 mL depolymerization solution and stir approx. 10 minutes to dissolve the alginate of the bead core. Appropriate dissolution time is dependent on the molecular weight and purity of the alginate, and the susceptibility of the encapsulation product to the depolymerization solution.
16. Drain off the depolymerization solution.
17. Pump in 150 mL MOPS washing buffer, resuspend the capsules and transfer them into the bead collecting flask.
18. Transfer the capsules in culture medium and cultivate them.

NOTE

Dissolved alginate diffuses out slowly. Depending on the alginate in use and the thickness of the capsule membrane, it can take up to 2 h for substantial amounts to leave the capsule. To maximize removal of the core you can:

- *Extend the extraction time in MOPS or in a culture medium without bivalent ions.*
- *Cultivate the cells in a medium containing < 50 mg/l of Ca ions.*
- *Cultivate the cells in a medium with a ratio of monovalent ions (Na^+ , K^+) to bivalent ions (Ca^{2+} , Mg^{2+}) between 20:1 and 50:1.*

Special recommendations for cells

For dividing cells - dissolve the core alginate, then maintain Na/Ca-ratio >20:1 in the culture medium so that the core will not re-solidify.

For resting cells – you can maintain the alginate core structure gelled and you can use even Ba²⁺, a stronger gelating ion than Ca²⁺. Ba-alginate is extremely stable and withstands dissolution by 50 mM citrate-solution for days.

Also see: Gröhn P. et al. 1994. Large-scale production of Ba²⁺ alginate-coated islets of Langerhans for immunoisolation. Exp. Clin. Endocrinol. 102: p.380-387.

6.15 Theoretical background

Equ. 1:
$$f = \frac{v}{\lambda} [\text{Hz}]$$

When a laminar jet is mechanically disturbed at the frequency f , beads of uniform size are formed¹. The optimal wavelength λ_{opt} for breakup, according to Weber² is given by:

Equ. 2:
$$\lambda_{opt} = \pi \sqrt{2} D \cdot \sqrt{1 + \frac{3\eta}{\sqrt{\rho\sigma D}}} [m]$$

where: D = nozzle diameter
 η = dynamic viscosity [Pa s]
 ρ = density [kg/m³]
 (ca. 1000 kg/m³ for alginate solutions)
 σ = surface tension [N/m]
 (ca. 55×10^{-3} N/m for alginate solutions)

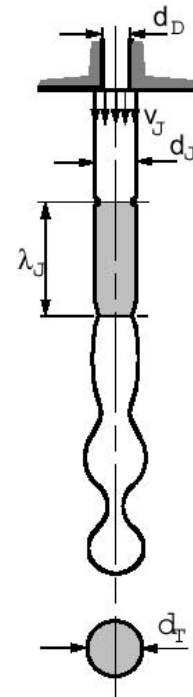

λ_{opt} is the optimal wavelength to get the best bead formation for the given nozzle diameter and the viscosity of the encapsulation mixture. It is possible to change λ_{opt} by 30 % and still achieve a good bead formation.

The diameter of a bead = d [m] can be calculated with the flow rate = V' [m³/s] and the frequency of the pulsation f according to:

Equ. 3:
$$d = \sqrt[3]{\frac{6V'}{\pi f}} [m]$$

The jet velocity = v [m/s] and the nozzle diameter = D [m] are correlated to the flow rate (V') according to:

Equ. 4:
$$V' = \frac{\pi v D^2}{4} [m^3/s]$$

Figure 6-5 shows the dependence of the flow rate to the jet velocity and the nozzle diameter as calculated by Equation 4. Because the liquid must flow laminafly the working range of the jet velocity will normally lay between 1.5 and 2.5 m/s, depending on the liquid viscosity and the nozzle diameter.

¹Lord Rayleigh 1878. Proc. London Math. Soc. 10:4.

²Weber C. 1936. Zeitschrift für angewandte Mathematik und Mechanik. 11:136.

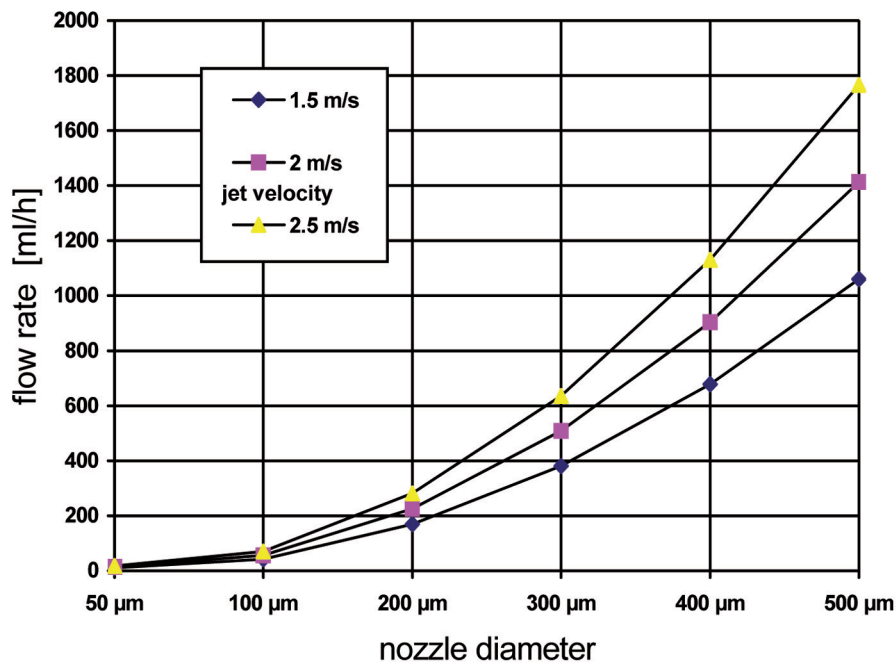

Figure 6-5: Influence of the liquid jet velocity and the nozzle diameter on flow rate, as calculated by Equation 4.

Figure 6-6 shows the correlation between the vibration frequency and the bead diameter for five different flow rates as calculated by equation 4. Lower flow rates, which corresponds to lower pumping rates, produce smaller beads. Higher vibration frequencies produce smaller beads also.

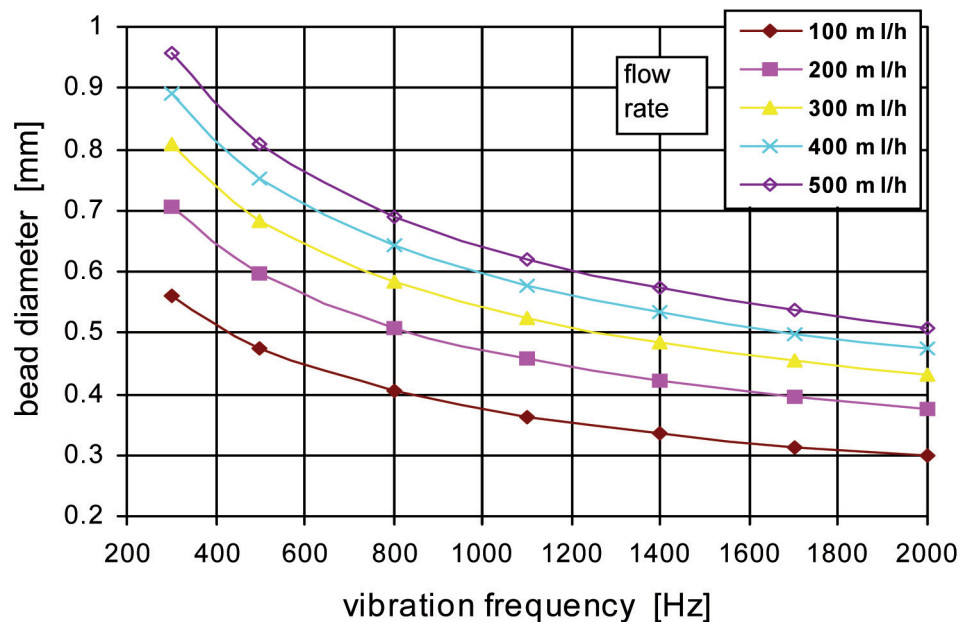

Figure 6-6: Influence of the vibration frequency and the flow rate on the bead diameter as calculated by Equation 4.

Table 6-7: Optimal working conditions for the Encapsulator determined with alginate solution

Nozzle diameter [μm]	Flow rate * [mL/min]	Frequency interval **	Amplitude	Air pressure [bar]
1.0 mm	30 to 40	40 to 220 Hz	2 to 6	0.3 to 0.6
750 μm	19 to 25	40 to 300 Hz	2 to 5	0.3 to 0.5
450 μm	9 to 14	150 to 450 Hz	2 to 5	0.3 to 0.5
300 μm	5.5 to 7	400 to 800 Hz	1 to 3	0.3 to 0.5
200 μm	3.5 to 4.5	600 to 1200 Hz	1 to 3	0.4 to 0.6
150 μm	2.3 to 2.8	800 to 1800 Hz	1 to 3	0.4 to 0.6
120 μm	1.5 to 1.8	1000 to 2500 Hz	1 to 4	0.5 to 0.7
80 μm	1.1 to 1.3	1300 to 3000 Hz	1 to 4	0.5 to 0.7

* Tested with 2 % low viscosity grade alginate solution for 750 μm and 1.0 mm nozzle, with 1.5 % alginate solution for the 150 to 500 μm nozzle and with 1.2 % alginate solution for the 80 and 120 μm nozzles.

**Upper values with application of high voltage.

NOTE

For solutions with a viscosity different from the tested one, it can be said that:

- *the higher the viscosity the higher the minimal jet velocity*
- *the higher the viscosity the higher the working flow rate*
- *the higher the viscosity the lower the optimal frequency*
- *the higher the viscosity the larger the beads*

6.15.1 Bead productivity and cell density

Figures 6-7 and 6-8 indicate the amount of beads formed from 1 mL of liquid. About 30'000 beads with a diameter of 0.4 mm will be formed, but only 2'000 with a diameter of 1 mm.

Figures 6-9 and 6-10 indicate the number of cells which are encapsulated in one bead for a given cell density and bead diameter. These figures may help you select the appropriate cell density in the immobilization mixture. For example, if the immobilization mixture contains 1×10^6 cells per mL, then about 33 cells are, on average, in each 0.4 mm bead, but, about 520 cells will be in each 1 mm bead.

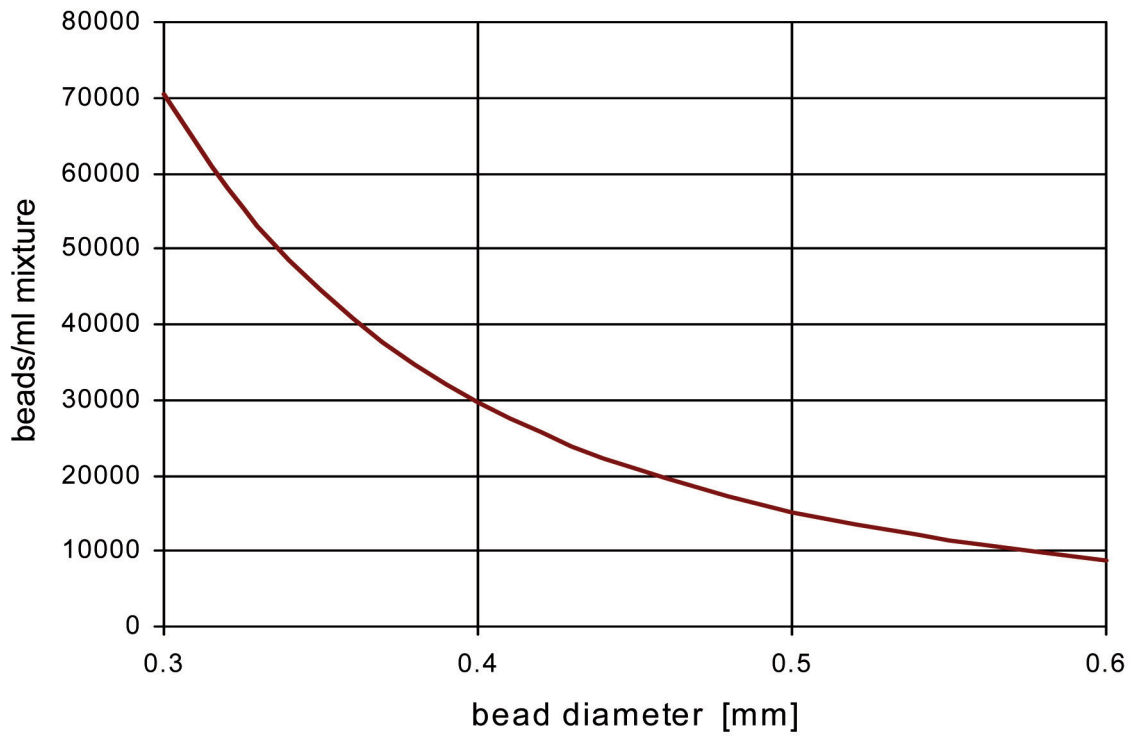

Figure 6-7: Amount of beads with a diameter of 0.3 to 0.6 mm formed from 1 mL of immobilization mixture.

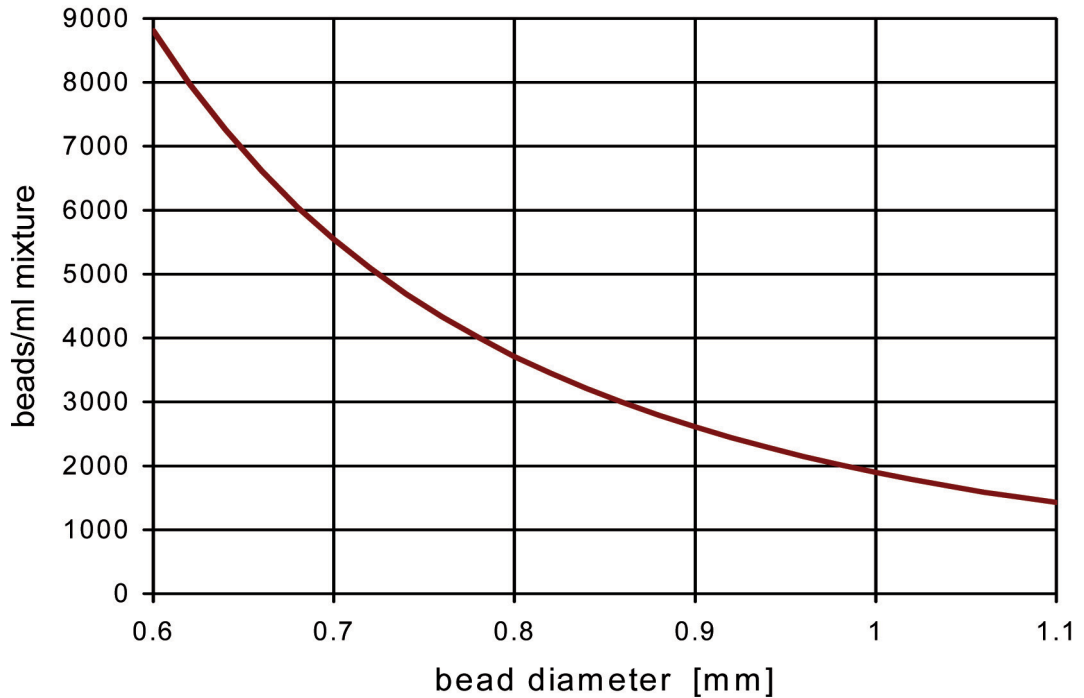

Figure 6-8: Amount of beads with a diameter of 0.6 to 1.1 mm formed from 1 mL of immobilization mixture.

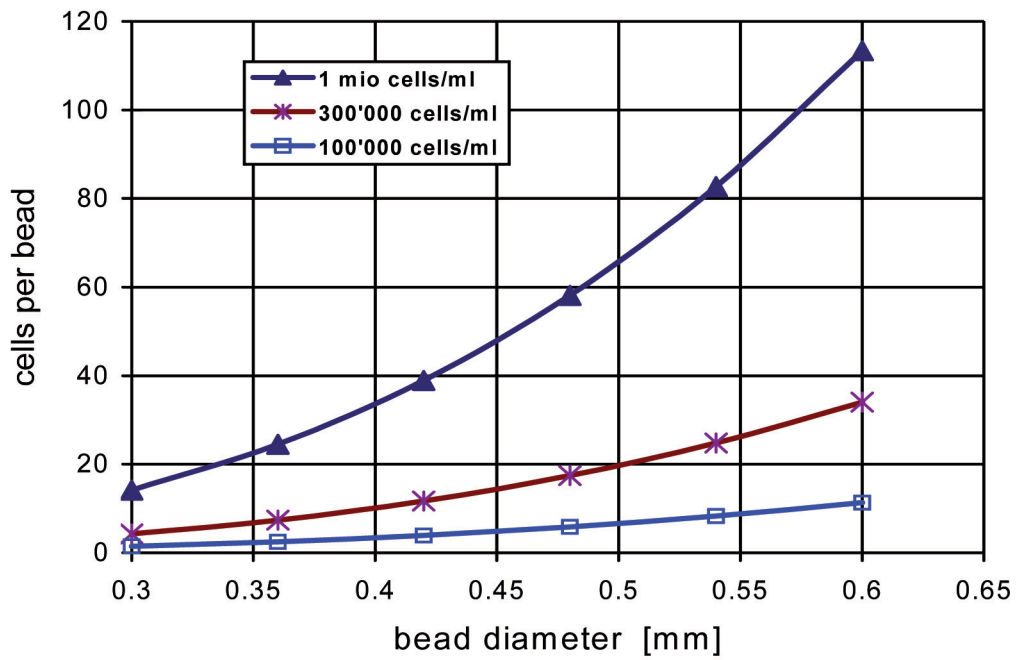

Figure 6-9: Amount of cells per bead made from different cell concentrations for bead diameters of 0.3 to 0.6 mm.

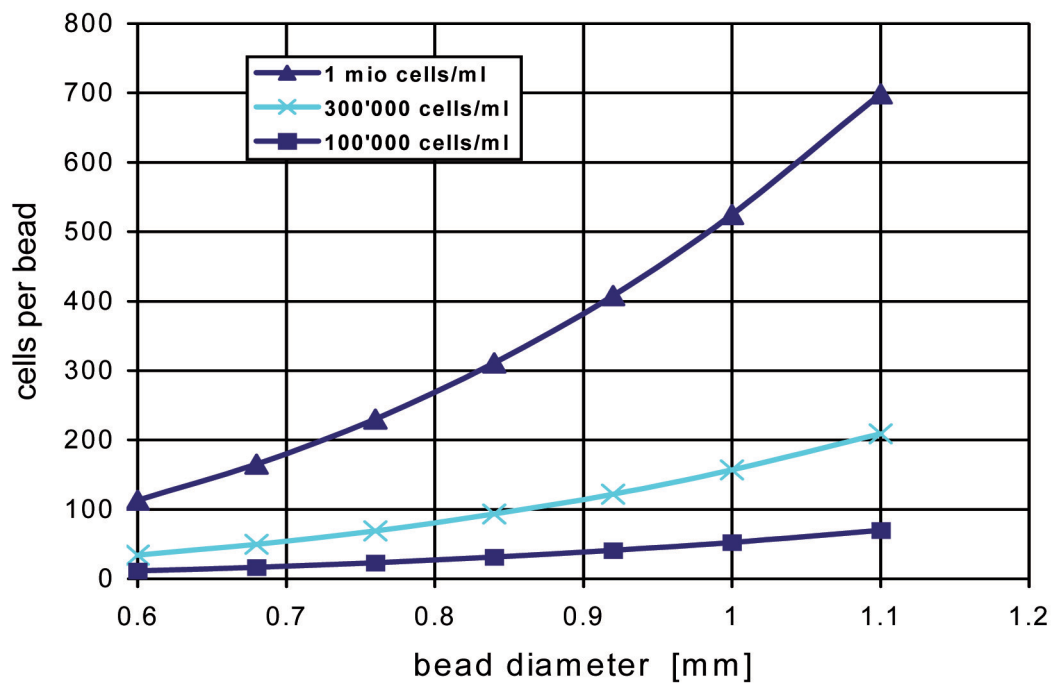

Figure 6-10: Amount of cells per bead made from different cell concentrations for bead diameters of 0.6 to 1.1 mm.

7 Maintenance and repairs

This chapter gives instructions on maintenance work to be performed in order to keep the instrument in good and safe working condition. All maintenance and repair work requiring the opening or removal of the instrument housing must be carried out by trained personnel and only with the tools provided for this purpose.

NOTE

Use only genuine consumables and spare parts for any maintenance and repair work in order to assure warranty and continued system performance. Any modifications of the Encapsulator B-395 Pro or parts of it need prior written permission of the manufacturer.

7.1 Customer service

Only authorized service personnel are allowed to perform repair work on the instrument. Authorization requires a comprehensive technical training and knowledge of possible dangers which might arise when working at the instrument. Such training and knowledge can only be provided by BUCHI.

Addresses of official BUCHI customer service offices are given on the BUCHI website under: www.buchi.com. If malfunctions occur on your instrument or you have technical questions or application problems, contact one of these offices.

The customer service offers the following:

- Spare part delivery
- Repairs
- Technical advice



7.2 Housing condition



Check the housing for visible defects (switches, plugs, cracks) and clean it regularly with a damp cloth. The Encapsulator control unit should be handled as with any other piece of electrical equipment. The front panel is covered by a polyamide sheet, so that it may be cleaned with a mild detergent solution or alcohol.

7.3 Sealing conditions

It is recommended to check the integrity of the sealings on a regular base. Gaskets, O-rings and silicone tubing should be replaced periodically (approximately once per year). Check all parts before use and replace if needed.

7.4 Cleaning

  	Warning
	<p>Pressure increasement in the inlet-system due to clogged nozzles.</p> <p>Bursting of the inlet system.</p> <p>Death or serious poisoning by contact or incorporation of harmful substances at use.</p> <ul style="list-style-type: none"> • Clean nozzle immediately after use, see following section.

	Wear laboratory coat
	Wear protective goggles
	Wear protective gloves

7.4.1 Cleaning the nozzle after each immobilization run

It is critical to clean the nozzle immediately after use so that the encapsulation medium (alginate, etc.) will not dry and clog the system.

1. Leave the nozzle in place on the bead producing unit.
2. Attach a 20 mL or 60 mL syringe to the bead producing unit and inject 20 to 60 mL of distilled water or of the solvent used for the encapsulation polymer.
3. If needed unscrew the nozzle from the bead producing unit, rinse with deionized water (see *figure 7-1*) or an appropriate solvent and dry the nozzle with a flush of air.

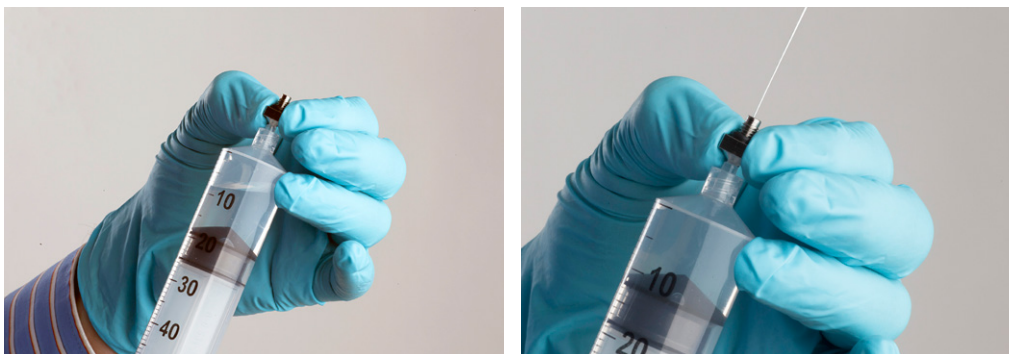

Figure 7-1: Cleaning procedure of the nozzle

- Take a syringe containing air on top and water on the bottom.
- Push the air through the nozzle (left figure).
- Push the water through the nozzle immediately afterwards (right figure).
- Examine the nozzle tip under a stereoscopic microscope to make sure the passage is clear and clean.

NOTE

If lipophilic immobilization solutions were used, then use appropriate solvents for cleaning. Do not use acid solution for alginate, as this would create a precipitate.

7.4.2 Cleaning a clogged nozzle

Unscrew the nozzle. Pass air or water through the nozzle as shown in *figure 7-1*.

If the nozzle tip is not clear, soak the nozzle in water, the appropriate solvent, in 1N NaOH or 1N sulfuric acid (never use HCl) according to the encapsulation mixture for 1 hour at room temperature, with periodic agitation. Sonication of full stainless steel nozzles is also a helpful procedure. Wear appropriate protection equipment. Rinse with distilled water, with air and let dry.

Examine the nozzle tip under a stereoscopic microscope to make sure the passage is clear and clean.

NOTE

If lipophilic immobilization solutions were used, then use appropriate solvents for cleaning. Do not use acid solution for alginate, as this would create a precipitate.

7.4.3 Cleaning the reaction vessel and the other vessels

Disassemble the reaction vessel. However the magnet holder should not be disassembled!

Disassemble the liquid transfer system.

Wash all parts, except the air filters, with a mild detergent solution, 0.01N NaOH or 0.01N sulfuric acid (never use HCl) as appropriate.

Rinse thoroughly with hot water, then with distilled water and let dry.

8 Troubleshooting

8.1 Malfunctions and their remedy

The table below lists possible operating errors and their cause. As remedy set the parameter stepwise in the opposite direction or fix the missing part.

Table 8-1: Possible cause

Problem	Possible cause
Unstable liquid stream	The liquid flow rate is too low.
	The nozzle is not adequately cleaned (frequent cause).
	The frequency is too high.
	The amplitude is too high.
Unstable bead chain	The frequency is too high or too low.
	The liquid flow rate is too high or too low.
	The Nozzle is not adequately cleaned.
	The amplitude is too low or too high.
Non-homogenous bead-size-distribution	The liquid flow rate is too high.
	The frequency is too high.
	The electrostatic tension is too low.
	The immobilization mixture is a non-Newtonian liquid, making it difficult to extrude or to prill.
The bead chain does not separate	The electrode is not connected to the control unit.
	The electrical tension is too low.
	The electrode is not on.
Beads are not visible in the strobo light	The vibration unit is not activated.
	The vibration unit is not put on the bead producing unit.
	The vibration frequency is too low or too high.
	The viscosity of the immobilization mixture is too high.

9 Shutdown, storage, transport and disposal

This chapter instructs how to shut down and to pack the instrument for storage or transport. Specifications for storage and shipping conditions can also be found listed here.

9.1 Storage and transport

Switch off the instrument and remove the power cord. To disassemble the Encapsulator B-395 Pro follow the installation instructions in section 5 in reverse order. Remove all liquids and dusty residues before packaging the instrument.

	<p>Warning</p> <p>Death or serious poisoning by contact or incorporation of harmful substances.</p> <ul style="list-style-type: none"> • Wear safety goggles • Wear safety gloves • Wear a laboratory coat • Clean the instrument and all accessories thoroughly to remove possibly dangerous substances • Do not clean dusty parts with compressed air • Store the instrument and its accessories at a dry place in its original packaging
--	--

9.2 Disposal

For instrument disposal in an environmentally friendly manner, a list of materials is given in *chapter 3.3*. This helps to ensure that the components can be separated and recycled correctly.

You have to follow valid regional and local laws concerning disposal. For help, please contact your local authorities!

NOTE

When returning the instrument to the manufacturer for repair work, please copy and complete the health and safety clearance form in section 10.2 and enclose it with the instrument.

10 Declarations and requirements

10.1 FCC requirements (for USA and Canada)

English:

This equipment has been tested and found to comply with the limits for a Class A digital device, pursuant to both Part 15 of the FCC Rules and the radio interference regulations of the Canadian Department of Communications. These limits are designed to provide reasonable protection against harmful interference when the equipment is operated in a commercial environment.

This equipment generates, uses and can radiate radio frequency energy and, if not installed and used in accordance with the instruction manual, may cause harmful interference to radio communications. Operation of this equipment in a residential area is likely to cause harmful interference in which case the user will be required to correct the interference at his own expense.

Français:

Cet appareil a été testé et s'est avéré conforme aux limites prévues pour les appareils numériques de classe A et à la partie 15 des réglementations FCC ainsi qu'à la réglementation des interférences radio du Canadian Department of Communications. Ces limites sont destinées à fournir une protection adéquate contre les interférences néfastes lorsque l'appareil est utilisé dans un environnement commercial.

Cet appareil génère, utilise et peut irradier une énergie à fréquence radioélectrique, il est en outre susceptible d'engendrer des interférences avec les communications radio, s'il n'est pas installé et utilisé conformément aux instructions du mode d'emploi. L'utilisation de cet appareil dans les zones résidentielles peut causer des interférences néfastes, auquel cas l'exploitant sera amené à prendre les dispositions utiles pour palier aux interférences à ses propres frais.

10.2 Health and Safety Clearance

Health and Safety Clearance

Declaration concerning safety, potential hazards and safe disposal of waste.

For the safety and health of our staff, laws and regulations regarding the handling of dangerous goods, occupational health and safety regulations, safety at work laws and regulations regarding safe disposal of waste, e.g. chemical waste, chemical residue or solvent, require that this form must be duly completed and signed when equipment or defective parts were delivered to our premises.

Instruments or parts will not be accepted if this declaration is not present.

Equipment

Model:

Part/Instrument no.:

1.A Declaration for non dangerous goods

We assure that the returned equipment

- has not been used in the laboratory and is new
- was not in contact with toxic, corrosive, biologically active, explosive, radioactive or other dangerous matters.
- is free of contamination. The solvents or residues of pumped media have been drained.



1.B Declaration for dangerous goods

List of dangerous substances in contact with the equipment:

Chemical, substance	Danger classification

We assure for the returned equipment that

- all substances, toxic, corrosive, biologically active, explosive, radioactive or dangerous in any way which have pumped or been in contact with the equipment are listed above.
- the equipment has been cleaned, decontaminated, sterilized inside and outside and all inlet and outlet ports of the equipment have been sealed.

2. Final Declaration

We hereby declare that

- we know all about the substances which have been in contact with the equipment and all questions have been answered correctly
- we have taken all measures to prevent any potential risks with the delivered equipment.

Company name or stamp: _____

Place, date: _____

Name (print), job title (print): _____

Signature: _____

BUCHI Affiliates:

Europe

Switzerland/Austria

BÜCHI Labortechnik AG
 CH – 9230 Flawil
 T +41 71 394 63 63
 F +41 71 394 65 65
 buchi@buchi.com
 www.buchi.com

Italy

BUCHI Italia s.r.l.
 IT – 20010 Cornaredo (MI)
 T +39 02 824 50 11
 F +39 02 575 12 855
 italia@buchi.com
 www.buchi.it

Benelux

BÜCHI Labortechnik GmbH
 Branch Office Benelux
 NL – 3342 GT Hendrik-Ido-Ambacht
 T +31 78 684 94 29
 F +31 78 684 94 30
 benelux@buchi.com
 www.buchi.be

Russia

BUCHI Russia/CIS
 Russia 127287 Moscow
 T +7 495 36 36 495
 F +7 495 98 10 520
 russia@buchi.com
 www.buchi.ru

France

BUCHI Sarl
 FR – 94656 Rungis Cedex
 T +33 1 56 70 62 50
 F +33 1 46 86 00 31
 france@buchi.com
 www.buchi.fr

United Kingdom

BUCHI UK Ltd.
 GB – Oldham OL9 9QL
 T +44 161 633 1000
 F +44 161 633 1007
 uk@buchi.com
 www.buchi.co.uk

Germany

BÜCHI Labortechnik GmbH
 DE – 45127 Essen
 T +800 414 0 414 0 (Toll Free)
 T +49 201 747 49 0
 F +49 201 747 49 20
 deutschland@buchi.com
 www.buechigmbh.de

Germany

BÜCHI NIR-Online
 DE – 69190 Walldorf
 T +49 6227 73 26 60
 F +49 6227 73 26 70
 nir-online@buchi.com
 www.nir-online.de

America

Brazil

BUCHI Brasil
 BR – Valinhos SP 13271-200
 T +55 19 3849 1201
 F +55 19 3849 2907
 brasil@buchi.com
 www.buchi.com

USA/Canada

BUCHI Corporation
 US – New Castle, DE 19720
 T +1 877 692 8244 (Toll Free)
 T +1 302 652 3000
 F +1 302 652 8777
 us-sales@buchi.com
 www.mybuchi.com

Asia

China

BUCHI China
 CN – 200052 Shanghai
 T +86 21 6280 3366
 F +86 21 5230 8821
 china@buchi.com
 www.buchi.com.cn

India

BUCHI India Private Ltd.
 IN – Mumbai 400 055
 T +91 22 667 75400
 F +91 22 667 18986
 india@buchi.com
 www.buchi.in

Indonesia

PT. BUCHI Indonesia
 ID – Tangerang 15321
 T +62 21 537 62 16
 F +62 21 537 62 17
 indonesia@buchi.com
 www.buchi.co.id

Japan

Nihon BUCHI K.K.
 JP – Tokyo 110-0008
 T +81 3 3821 4777
 F +81 3 3821 4555
 nihon@buchi.com
 www.nihon-buchi.jp

Korea

BUCHI Korea Inc.
 KR – Seoul 153-782
 T +82 2 6718 7500
 F +82 2 6718 7599
 korea@buchi.com
 www.buchi.kr

Malaysia

BUCHI Malaysia Sdn. Bhd.
 MY – 47301 Petaling Jaya,
 Selangor
 T +60 3 7832 0310
 F +60 3 7832 0309
 malaysia@buchi.com
 www.buchi.com

Singapore

BUCHI Singapore Pte. Ltd.
 SG – Singapore 609919
 T +65 6565 1175
 F +65 6566 7047
 singapore@buchi.com
 www.buchi.com

Thailand

BUCHI (Thailand) Ltd.
 TH – Bangkok 10600
 T +66 2 862 08 51
 F +66 2 862 08 54
 thailand@buchi.com
 www.buchi.co.th

BUCHI Support Centers:

South East Asia

BUCHI (Thailand) Ltd.
 TH-Bangkok 10600
 T +66 2 862 08 51
 F +66 2 862 08 54
 bacc@buchi.com
 www.buchi.com

Middle East

BÜCHI Labortechnik AG
 UAE – Dubai
 T +971 4 313 2860
 F +971 4 313 2861
 middleeast@buchi.com
 www.buchi.com

Latin America

BUCHI Latinoamérica Ltda.
 BR – Valinhos SP 13271-200
 T +55 19 3849 1201
 F +55 19 3849 2907
 latinoamerica@buchi.com
 www.buchi.com

We are represented by more than 100 distribution partners worldwide.
 Find your local representative at: www.buchi.com