

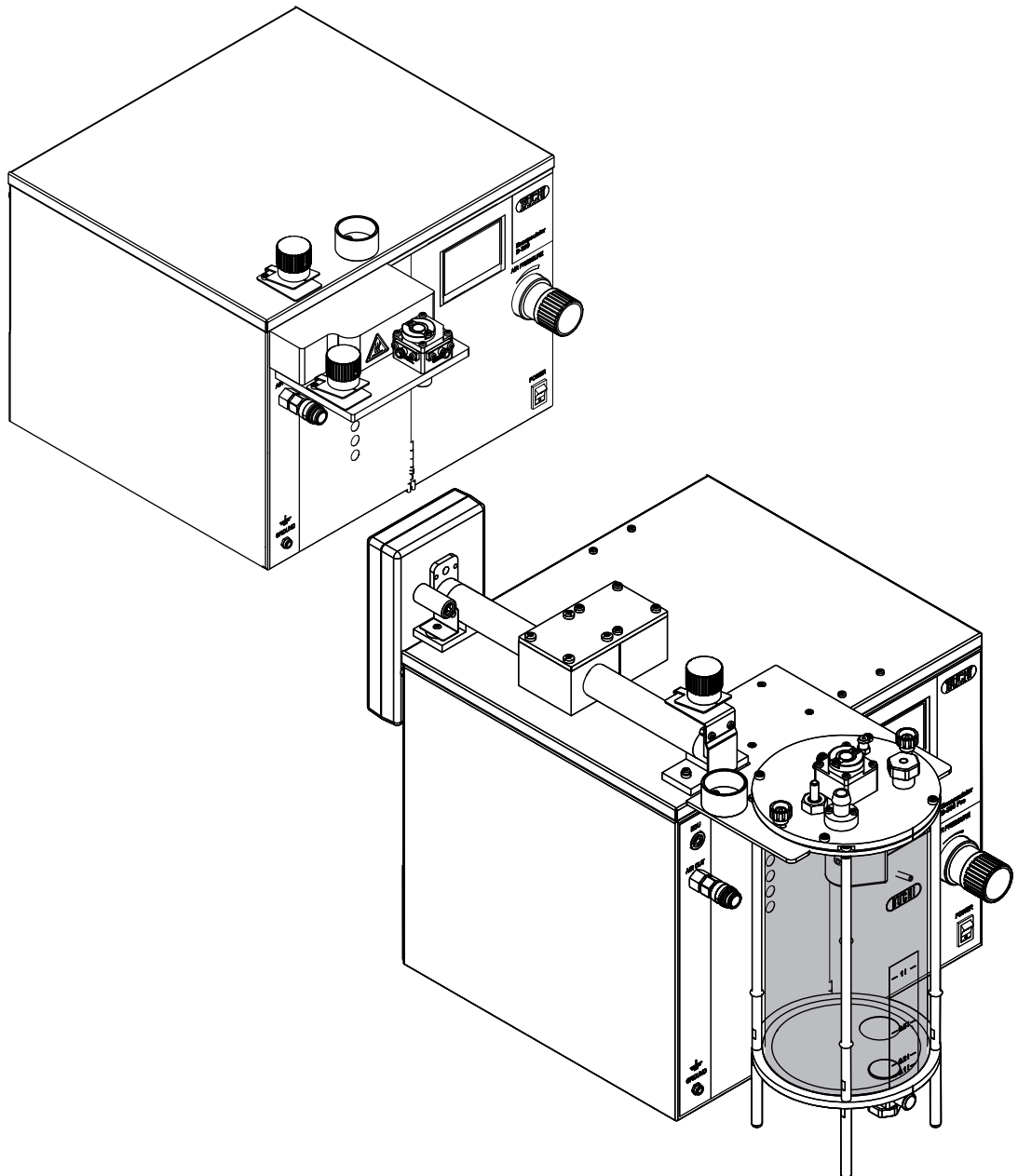

# Encapsulator B-390 / B-395 Pro

## Technical data sheet

Production of functionalized beads and core-shell capsules with narrow size distribution are the key benefits of this system. BUCHI offers the Encapsulator to immobilize active ingredients from biological, organic or inorganic origin within numerous polymers for your R&D work.



## Overview of solutions

The Encapsulator is available in different versions and configurations to cover a broad range of applications. With their numerous accessories, the Encapsulator B-390 and B-395 Pro can be used to produce monodispersed droplets from various material. Those droplets can further be hardened to form functionalized beads and core-shell capsules. Working under sterile condition is more over available with the Encapsulator B-395 Pro.

### Functionalized beads

Beads can be understood as solid spheres with homogenous structure and narrow particle size distribution. Functionality is given by the encapsulated substances that can be of biological, organic or inorganic origin.

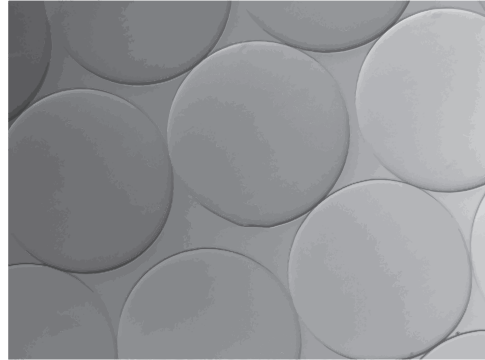

### Functionalized core-shell capsules

Core-shell capsules differ from beads by their structure. In contrast to beads, they are composed of one liquid core surrounded by a solid shell. As for beads, functionality is given by the encapsulated substances that can be of biological, organic or inorganic origin.

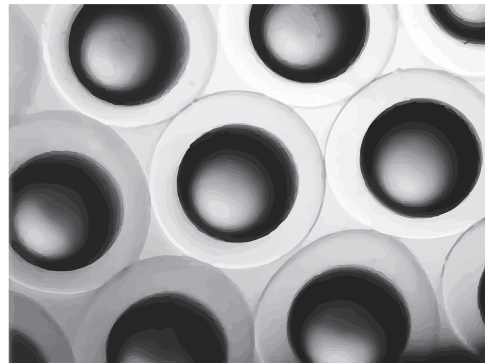

### Encapsulator B-390

The Encapsulator B-390 was designed to produce beads and core-shell capsules in open conditions.

The liquid is pushed to the bead producing unit using air pressure. The instrument has an integrated heating block allowing to prill melts like gelatin or wax.

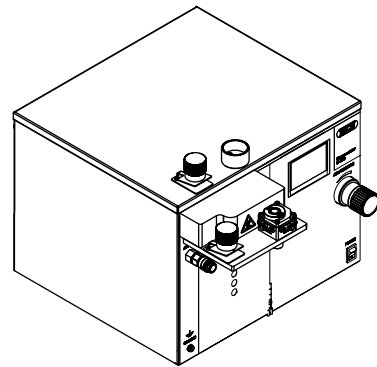

### Encapsulator B-395 Pro

The Encapsulator B-395 Pro was optimized for the microencapsulation of cells under sterile working conditions.

Liquid can be pumped by the integrated syringe pump and/or by air pressure.

The instrument incorporates a reaction vessel allowing sterile introduction and removal of fluids and products. The reaction vessel is also available with materials certificates for product touching parts as an option.

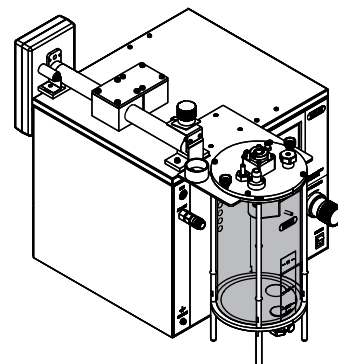

## Order code

Choose the configuration according to your needs:



Encapsulator (100 - 240 V / 50 - 60 Hz)

10 B-390

20 B-395 Pro

30 B-395 Pro with materials certificates for GMP documentation

## Scope of delivery

All configurations are supplied ready to use.

Component	B-390	B-395	B-395 Pro with materials certificates for GMP documentation
Single nozzle system	•	•	•
Vibration coil	•	•	•
Bead charging electrode	•	•	•
Tubing set	•	•	•
Toolbox	•	•	•
Pressure bottle 500 mL	•	•	•
Pressure bottle 1000 mL		•	•
Reaction vessel		•	•
Heating block for hot prilling	•		
Magnetic stirrer		•	•
Included syringe pump		•	•
Materials certificates*			•
Operation manual	•	•	•

\* Parts in contact with product

## Technical data

### Encapsulator

Specification	B-390	B-395
Dimensions (W x D x H)	320 x 340 x 290 mm	320 x 480 x 380 mm
Weight	7 kg	11 kg
Power consumption	max. 150 W	max. 150 W
Connection voltage	100-240 VAC	100-240 VAC
Frequency	50/60 Hz	50/60 Hz
Max. allowed air pressure in the system	1.5 bar	1.5 bar
Pump rate by air pressure	0.5 to 200 mL/min	0.5 to 200 mL/min
Syringe pump rate	-	0.01 to 50 mL/min
Heating	10 – 80°C	-
Vibration frequency	40 to 6000 Hz	40 to 6000 Hz
Electrode tension	250 to 2500 V	250 to 2500 V
Reactor gross volume	-	4.5 L
Reactor working volume	-	2 L
Nozzle diameter of single nozzles	0.08, 0.12, 0.15, 0.2, 0.3, 0.45, 0.75, 1.0 mm	0.08, 0.12, 0.15, 0.2, 0.3, 0.45, 0.75, 1.0 mm
Pollution degree	2	2
Overvoltage category	II	II

### Ambient conditions

For indoor use only.

Max. altitude above sea level	2000 m
Ambient temperature	5–40 °C
Maximum relative humidity	Maximum relative humidity 80% up to 31°C, then decreasing linearly to 50% relative humidity at 40 °C

### Materials

Component	B-390	B-395
Bead producing unit	Stainless steel, POM Sealings: EPDM	Stainless steel, POM Sealings: EPDM
Nozzles	Stainless steel Sealings: EPDM	Stainless steel Sealings: EPDM
Pressure bottles	3.3 borosilicate glass, FEP, PTFE, PP Sealings: silicone, EPDM	3.3 borosilicate glass, FEP, PTFE, PP Sealings: silicone, EPDM
Reaction vessel	-	Stainless steel Sealings: silicone, EPDM

## Description of function

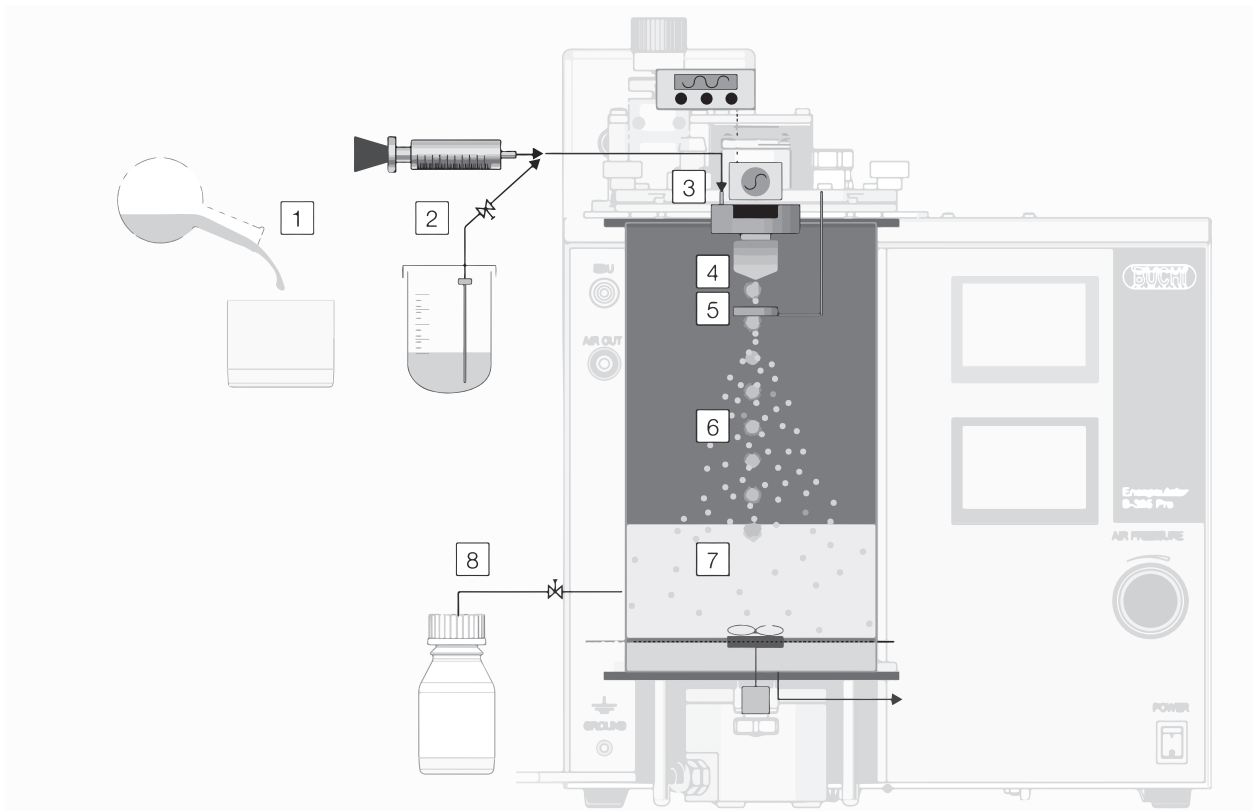

1. Mixing of active ingredient and polymer
2. Pumping mixture with syringe pump or air pressure until a stable jet is obtained.
3. Determination of suitable vibration frequency
4. Droplet formation
5. Electrostatic charge and dispersion of the droplets
6. Visual process control of droplet formation in the light of the stroboscopic lamp
7. Bead curing through physical or chemical reaction
8. Collection of beads

The Encapsulator can disintegrate most extrudable solutions (<400 cps) into equally sized droplets. This is the first prerequisite for a successful production of homogenous functionalized beads or core-shell capsules. The second prerequisite is a very fast hardening reaction, that can be chemically (i.e ionic gelation) or physically (i.e. cooling etc.) induced. The instrument has successfully been used to produce homogenous particles out of polymers such as alginate, chitosan, pectin and different types of waxes.

The most frequently encountered functionalized beads and core-shell capsules are based on alginate. Its very fast ionic gelation reaction with  $\text{Ca}^{2+}$  ions is ideal to form equally sized beads or core-shell capsules. Thanks to this property, alginate is often used in combination with other polymers. The table below shows examples for polymers and its corresponding solidification agents giving a fast enough hardening reaction.

Polymer	Solidification agent
Alginate	Bivalent ions (except $\text{Mg}^{2+}$ ) such as $\text{Ca}^{2+}$ , $\text{Ba}^{2+}$ , $\text{Sr}^{2+}$ , $\text{Fe}^{3+}$
Chitosan	Tripolyphosphate (TPP)
Pectin	Oligochitosan
Wax	Cooling (i.e. liquid nitrogen etc.)

## Nozzle configurations

BUCHI offers various nozzle systems that perfectly fit specific applications. The table below assists you in finding the appropriate nozzle system for your beads or core-shell capsules.

Properties	Single nozzle system	Concentric nozzle system	Flow vibration system	Air dripping system	Big capsules nozzle
Production of beads	•		•	•	
Production of core-shell capsules		•			•
Smallest particle diameter [µm]	150	400	80	500	-
Largest particle diameter [µm]	2000	1800	1000	800	4000
Lowest productivity* [mL/min]	1.1	3.5	1.1	9	Low
Highest productivity* [mL/min]	40	30	25	13	Low
Vibration only	•	•			
Vibration & air dispersion			•		
Air dispersion only				•	
Sample viscosity < 400 cps	•	•	•	•	•
Sample viscosity > 400 cps			•		(•)
Compatibility with B-390	•	•	•	(•)	•
Compatibility with B-395 Pro	•	•	•	•	•



\*productivity highly depends on the nozzle size. Smaller nozzle sizes result in lower flow rates, hence in lower productivity. Larger nozzle sizes result in higher flow rates, hence higher productivity.

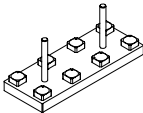
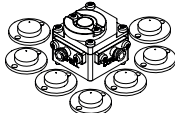
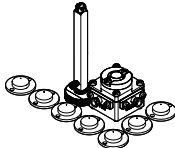
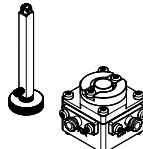

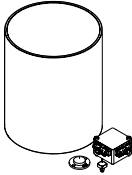
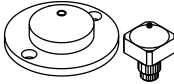
## Accessories

	Order no.	Image
<p>Single nozzle set</p> <p>Set of 8 single nozzles with high precision opening of 0.08, 0.12, 0.15, 0.2, 0.3, 0.45, 0.75 and 1 mm made of stainless steel including nozzle rack</p>	11057918	
<p>Concentric nozzle set</p> <p>Nozzle set for core-shell capsule production. Includes a pulsation chamber plus a set of 7 external nozzles with high precision opening of 0.2, 0.3, 0.4, 0.5, 0.6, 0.7 and 0.9 mm, made in stainless steel, to be used in combination with the single nozzle set. A 1000 mL pressure bottle is included.</p>	11058051	
<p>Flow vibration nozzle set</p> <p>Nozzle set for bead production. Includes pulsation chamber plus a set of 7 external nozzles with high precision opening of 0.2, 0.3, 0.4, 0.5, 0.6, 0.7 and 0.9 mm made of stainless steel to be used in combination with the single nozzle set. An airflow controller is also included.</p>	11060030	
<p>Upgrade concentric nozzle to flow vibration nozzle</p> <p>Upgrade set for bead production of samples using flow vibration for users owning the concentric nozzle system. Includes pulsation chamber and an airflow controller.</p>	11060055	

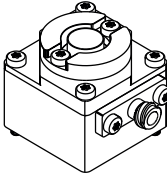
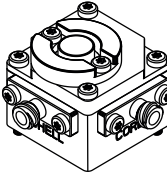
	Order no.	Image
<p>Air dripping nozzle set</p> <p>Air dispersion nozzle specifically designed for the gentle encapsulation of cell agglomerates and islet cells. Includes an elongated core nozzle 0.4 mm, a shell nozzle 1.5 mm, the chamber and two short glass cylinders.</p>	11060033	
<p>Upgrade bigger capsules</p> <p>Upgrade for concentric nozzle set, flow vibration nozzle set or air dripping nozzle set to produce bigger capsules up to 4 mm by means of drop separation process.</p>	11060020	

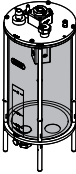
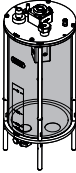
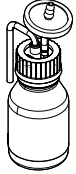
## Spare Parts

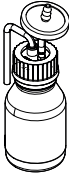
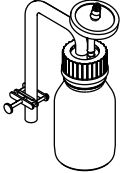
	Order no.	Image
<p>Pulsation chamber</p> <p>Pulsation chamber to be used with single nozzle system. Includes a set of 5 metallic membranes.</p>	11058178	
<p>Concentric pulsation chamber</p> <p>Pulsation chamber to be used with concentric nozzle system. Includes a set of 5 metallic membranes.</p>	11058277	
<p>Magnets</p> <p>Set of 2 magnets with thread.</p>	11063770	
<p>Reaction vessel</p> <p>Completely autoclavable reactor made of glass and stainless steel for sterile production and collection of microbeads and core-shell capsules, 2 L working volume. Includes a pulsation chamber for single nozzle system.</p>	11057890	
<p>Reaction vessel with material certificates</p> <p>Completely autoclavable reactor made of glass and stainless steel for sterile production and collection of microbeads and core-shell capsules with materials certificates, 2 L working volume. Includes materials certificates and pulsation chamber for single nozzle system.</p>	11057879	
<p>Pressure bottle 500 mL</p> <p>Glass bottle with fittings, tubes and air filter, working pressure up to 1.5 bar, autoclavable</p>	11058190	

	Order no.	Image
Pressure bottle 1000 mL Glass bottle with fittings, tubes and air filter, working pressure up to 1.5 bar, autoclavable	11058191	
Bead collection flask 250 mL glass bottle with fittings, tubes and air filter, autoclavable	11057956	
Grounding set	11058189	

## Wearing parts

	Order no.
Nozzle 80 µm + 5 O-rings	11060633
Nozzle 120 µm + 5 O-rings	11060634
Nozzle 150 µm + 5 O-rings	11060635
Nozzle 200 µm + 5 O-rings	11060636
Nozzle 300 µm + 5 O-rings	11060637
Nozzle 450 µm + 5 O-rings	11060638
Nozzle 750 µm + 5 O-rings	11060639
Nozzle 1000 µm + 5 O-rings	11060640
Set of sealings for single nozzle system O-rings: 3.69x1.78 (5 pcs), 4.48x1.78 (8 pcs) Flat gaskets: 18.0/14.0 x 1.5 (3 pcs)	11057954
Set of sealings for concentric nozzle system O-rings: 3.69x1.78 (4 pcs), 12.42x7.78 (4 pcs) Flat gaskets: 18.0/14.0 x 1.5 (3 pcs)	11057955
Set of sealings for reaction vessel O-rings: 3.69x1.78 (4 pcs), 5x1 (3 pcs), 6x2 (10 pcs), 10.82x1.78 (4 pcs), 18.77 x 1.78 (4 pcs), 29.87x1.78 (2 pcs), 31.42x2.62 (2 pcs), 34.65x 1.78 (2 pcs), 117.1x3.53 (2 pcs) Flat gaskets: 110x124x3 (3 pcs)	11057970
Tubing set for Encapsulator Includes Silicon hose 4.0/7.0x615, silicone hose 5/8x350, FEP hose 4/6x320, blue plastic hose 4.0/2.6x3000	11058186
Metallic membranes Set of 5 metallic membranes with thread.	11063771
Pre-filters for nozzle diameter 7 mm (10 pcs)	11057957



	Order no.
Drain filters for reaction vessel diameter 35 mm (10 pcs)	11057958
Luer-Lock male (10 pcs)	11060037

## Consumables

	Order no.
Sodium alginate powder 500 g of low viscosity grade alginate powder	11059994

## Documentation and Training

	Order no.
IQ/OQ set B-395 Pro	11064846
Repeating OQ set B-395 Pro	11064847