

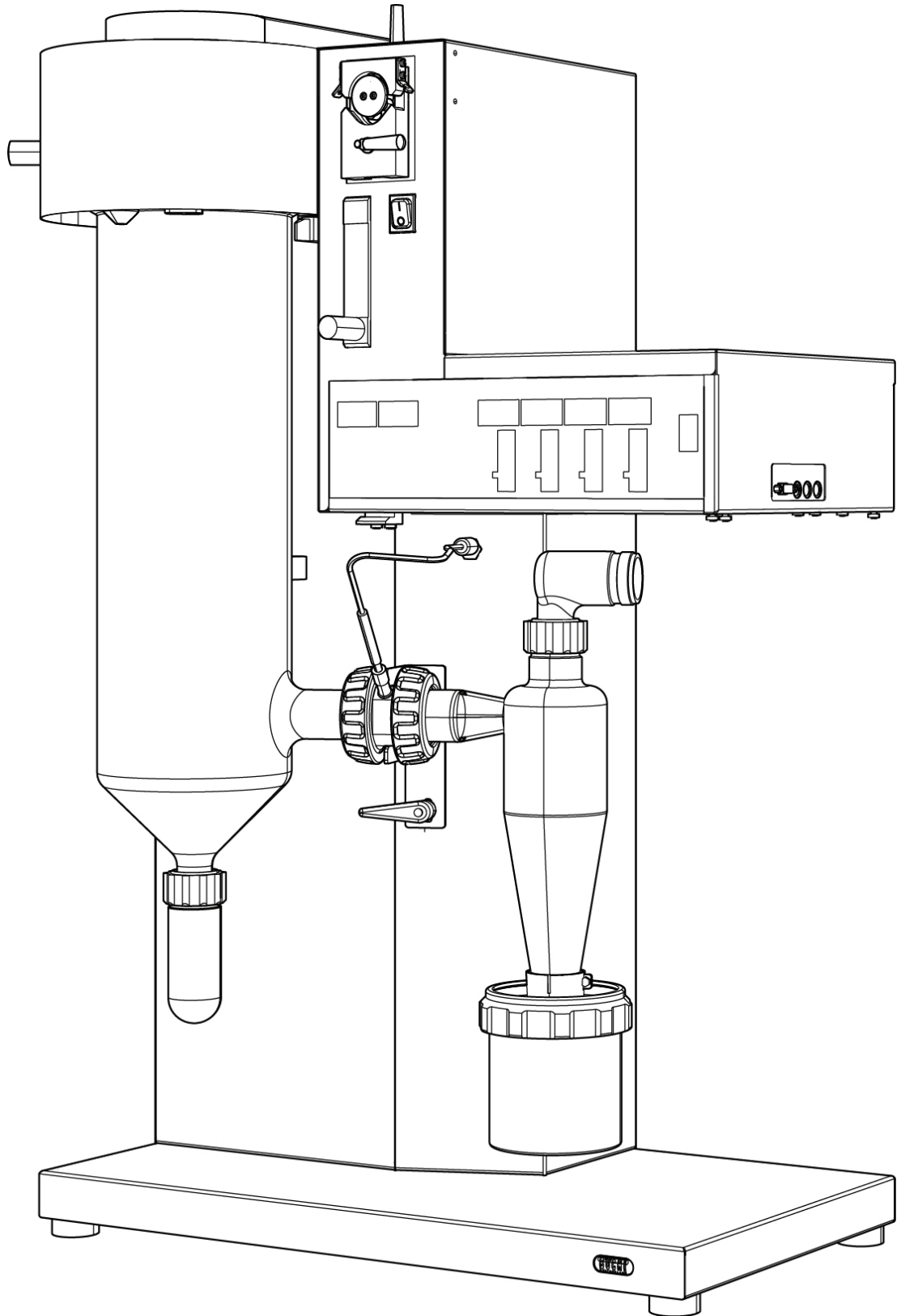

# B-290 Mini Spray Dryer

## Operation Manual



## **Imprint**

Product Identification:  
Operation Manual (Original), Mini Spray Dryer B-290

093001|Q en

Publication date: 01.2020

BÜCHI Labortechnik AG  
Meierseggstrasse 40  
Postfach  
CH-9230 Flawil 1

E-Mail: [quality@buchi.com](mailto:quality@buchi.com)

BUCHI reserves the right to make changes to the manual as deemed necessary in the light of experience; especially in respect to structure, illustrations and technical detail.

This manual is copyright. Information from it may not be reproduced, distributed, or used for competitive purposes, nor made available to third parties. The manufacture of any component with the aid of this manual without prior written agreement is also prohibited.

## Table of contents

1	About this manual . . . . .	6
2	Safety . . . . .	7
2.1	User qualification . . . . .	7
2.2	Proper use . . . . .	7
2.3	Improper use . . . . .	8
2.4	Safety warnings and safety signs used in this manual . . . . .	8
2.5	Product safety . . . . .	10
2.5.1	General hazards . . . . .	10
2.5.2	Warning labels on housing and assemblies . . . . .	14
2.5.3	Personal protective equipment . . . . .	14
2.5.4	Safety elements and measures . . . . .	15
2.6	General safety rules . . . . .	16
3	Technical data . . . . .	17
3.1	Scope of application and delivery . . . . .	17
3.1.1	Standard instrument . . . . .	17
3.1.2	Standard accessories . . . . .	18
3.1.3	Standard accessories with the B-290 Advanced . . . . .	18
3.1.4	Standard accessories with the B-290 Acid resistant . . . . .	18
3.1.5	Optional accessories . . . . .	19
3.2	Technical data overview . . . . .	20
3.3	Materials used . . . . .	21
4	Description of function . . . . .	22
4.1	Functional principle of the drying gas . . . . .	22
4.2	Functional principle of the sample feed and dispersion . . . . .	22
4.3	Outlet filter . . . . .	23
4.4	Inert Loop B-295 . . . . .	23
4.5	Dehumidifier B-296 . . . . .	24
4.6	Spray chilling accessory . . . . .	25
4.7	Connected accessories to the Mini Spray Dryer B-290 . . . . .	25
4.7.1	Feed switch valve and remote control panel . . . . .	26
4.7.2	Printer or PC for data output via RS-232 serial port . . . . .	26
5	Putting into operation. . . . .	27
5.1	Installation site . . . . .	27
5.2	Electrical connections . . . . .	27
5.3	Installing the compressed air maintenance unit and compressor (optional) . . . . .	29
5.4	Installing the glass assembly . . . . .	30
5.5	Installing the spraying nozzle. . . . .	31
5.6	Installing the filters . . . . .	32
5.6.1	Inlet filter installation . . . . .	33
5.6.2	Outlet filter installation. . . . .	33
5.6.3	PTFE filter membrane installation . . . . .	34
5.6.4	Cleaning filter installation . . . . .	36
5.7	Adjusting the peristaltic pump bed and choosing the feeding tube . . . . .	36
5.8	Tubing installation. . . . .	38
5.9	Installing the compressor . . . . .	39
5.10	Quick hose couplings. . . . .	40

5.11	Installing the Inert Loop B-295 . . . . .	40
5.12	Dehumidifier B-296 and Inert Loop B-295 combination . . . . .	43
5.13	Installing the Dehumidifier B-296 . . . . .	43
5.14	Installing the Spray Chilling Accessory . . . . .	45
5.15	Installation check . . . . .	46
6	Operation. . . . .	47
6.1	Layout of the operating and display elements . . . . .	48
6.2	Conversion tables for the parameters. . . . .	49
6.2.1	Flow meter spraying air (rotameter). . . . .	49
6.2.2	Peristaltic pump . . . . .	49
6.2.3	Aspirator . . . . .	50
6.3	Spray process . . . . .	50
6.4	Optimizing parameters. . . . .	51
6.5	End of spray process . . . . .	51
6.6	Recovering particles of the outlet filter. . . . .	52
6.7	Operation with the Inert Loop B-295 . . . . .	53
6.7.1	Status messages . . . . .	54
6.8	Operation with the Spray Chilling Accessory . . . . .	55
6.9	Mini Spray Dryer B-290 acid resistant . . . . .	56
7	Maintenance and repairs . . . . .	57
7.1	Housing . . . . .	58
7.2	Glass assembly, tubes. . . . .	58
7.3	Nozzles . . . . .	58
7.4	Aspirator cleaning . . . . .	59
7.5	Inert Loop B-295 and Dehumidifier B-296 . . . . .	59
7.6	Outlet filter . . . . .	60
7.7	Calibrating the oxygen sensor of the Inert Loop B-295. . . . .	60
7.8	Replacing the oxygen sensor of the Inert Loop B-295 . . . . .	61
7.9	Spray chilling accessory . . . . .	61
7.10	Customer service. . . . .	61
8	Troubleshooting . . . . .	62
8.1	Error messages and their remedy . . . . .	62
8.2	Malfunctions and their remedy. . . . .	63
9	Shutdown, storage, transport and disposal . . . . .	65
9.1	Storage and transport . . . . .	65
9.2	Disposal . . . . .	65
10	Spare parts . . . . .	66
10.1	Spray nozzle. . . . .	66
10.2	Glass parts . . . . .	70
10.3	Filters . . . . .	72
10.4	Tubings and connectors . . . . .	72
10.5	Trolley . . . . .	73
10.6	Measurement pipe for gas flow . . . . .	73
10.7	Feed switch valve . . . . .	74
10.8	Remote control panel. . . . .	74
10.9	Inert Loop B-295 . . . . .	74
10.10	Cylinder insulation. . . . .	75
10.11	Spray chilling accessory . . . . .	76
10.12	Pre-cleaning glass-set and sterile filter . . . . .	77
10.13	Acid resistant accessories . . . . .	78



11 Declarations and requirements . . . . .79  
11.1 FCC requirements (for USA and Canada). . . . .79  
11.2 Safety certificate . . . . .80

# 1 About this manual

This manual describes the Mini Spray Dryer B-290 and its optional accessories and provides all information required for its safe operation and to maintain it in good working order.

It is addressed to laboratory personnel and operators in particular.

Read this manual carefully before installing and running your system and note the safety precautions in chapter 2 in particular. Store the manual in the immediate vicinity of the instrument, so that it can be consulted at any time.

No technical modifications may be made to the instrument without the prior written agreement of BUCHI. Unauthorized modifications may affect the system safety or result in accidents. Technical data are subject to change without notice.

## NOTE

The symbols pertaining to safety are explained in chapter 2.

This manual is copyright. Information from it may not be reproduced, distributed or used for competitive purposes, nor made available to third parties. The manufacture of any component with the aid of this manual without prior written agreement is also prohibited.

The English manual is the original language version and serves as basis for all translations into other languages. If you need another language version of this manual, you can download other versions at [www.buchi.com](http://www.buchi.com) or reorder manuals from a BUCHI representative.

## Abbreviations

EPDM: Ethylene Propylene Dimonomer

FFKM: Perfluoroelastomers

FPM: Fluoroelastomer

PEEK: Polyetheretherketone

PTFE: Polytetrafluoroethylene

POM: Polyoxymethylene

PFA: Perfluoroalkoxy

## 2 Safety

This chapter highlights out the safety concept of the instrument and contains general rules of behavior and warnings from direct and indirect hazards concerning the use of the product.

For the users safety, all safety instructions and safety messages in the individual sections shall be strictly observed and followed. Therefore, the manual must always be available to all persons performing any tasks described herein.

### 2.1 User qualification

The instrument is designed and built in accordance with state-of-the-art technology. Nevertheless, risks to users, property, and the environment can arise when the instrument is used carelessly or improperly. The manufacturer has determined residual dangers emanating from the instrument

- if the instrument is operated by insufficiently trained personnel without supervision.
- if the instrument is not operated according to its proper use.

Appropriate warnings in this manual serve to make the user alert to these residual hazards.

Personnel without this training or persons who are currently being trained require careful instruction.

The present Operation Manual serves as the basis for this.

### 2.2 Proper use

The Mini Spray Dryer B-290 has been designed and built as laboratory instrument and for batch production. It serves to spray-dry aqueous solutions or suspensions in one operating process. In combination with the Inert Loop B-295, it is possible to work with organic solvents in "closed mode". Processing in "closed mode" requires N<sub>2</sub> as an inert gas.

The output particle size of the Mini Spray Dryer B-290 is between 2–25 µm. Thus, the instrument is suited to generate particles in the inhalable size range from a solution of suspension.

- If the instrument is used with potentially toxic or hazardous substances, it has to be installed inside a closed fume hood or glove box. In such cases, the complete processing and system handling has to be performed within the ventilated box to avoid toxication and other hazardous situations to the user and the environment.
- Spray drying of corrosive samples require handling in a closed fume hood. An acid proof system in open loop is a variant of the Mini Spray Dryer B-290.
- In any case, all exhausts leaving the exhaust gas tubing have to be lead away instantly by a ventilation system, to remove possibly hazardous substances and fumes from the working area. The ventilation system has to be equipped with safety measures such as outlet filters to avoid contamination of the environmen.
- Operation and handling can require additional personal protective equipment. Operate the instrument with respect to standard laboratory safety rules (i.e. as stated in the latest version of the WHO "Laboratory biosafety manual") at all times.
- If the Mini Spray Dryer B-290 is used in combination with other instruments (e.g. Chiller) all related manuals are to be fully observed.
- Electrostatic charges are to be arrested from both the product collection vessel and the cyclone via the standard grounding cable if the cyclone is equipped with a grounding socket.
- If the instrument is used for food, pharma and cosmetic products additional cleaning measures are required.

## 2.3 Improper use

Applications not mentioned in section 2.2 are considered to be improper. Also, applications which do not comply with the technical data (see section 3 of this manual) are considered to be improper. The operator bears the sole risk for any damages or hazards caused by such improper use.



The following uses are expressly forbidden:

- Use of gases with unknown chemical composition.
- Spray drying of biohazardous materials such as viruses or bacteria.
- Use of the instrument with organic solvents (> 20 %) without safety lamella curtain and Inert Loop B-295.
- Use of the instrument with organic solvents (> 20 %) in open mode.
- Use of the instrument in rooms which require ex-protected instruments.
- Spray drying of substances which might explode or ignite due to the processing and the selected parameters of the Mini Spray Dryer B-290 or installed sub systems.
- Spray drying of toxic substances.
- Use of samples which might produce oxygen during the processing.
- Unattended use.

## 2.4 Safety warnings and safety signs used in this manual

DANGER, WARNING, CAUTION and NOTICE are standardized signal words for identifying levels of hazards and risks related to personal injury and property damage. All signal words, which are related to personal injury are accompanied by the general safety sign.

For your safety it is important to read and fully understand the table below with the different signal words and their definitions!

Sign	Signal word	Definition	Risk level
	<b>DANGER</b>	Indicates a hazardous situation which, if not avoided, will result in death or serious injury.	★★★★
	<b>WARNING</b>	Indicates a hazardous situation which, if not avoided, could result in death or serious injury.	★★★☆
	<b>CAUTION</b>	Indicates a hazardous situation which, if not avoided, may result in minor or moderate injury.	★★☆☆
no	<b>NOTICE</b>	Indicates possible property damage, but no practices related to personal injury.	★☆☆☆ (property damage only)

Supplementary safety information symbols may be placed in a rectangular panel on the left to the signal word and the supplementary text (see example below).















Space for supplementary safety information symbols.	 <b>SIGNAL WORD</b>
	Supplementary text, describing the kind and level of hazard/risk seriousness. <ul style="list-style-type: none"> <li>• List of measures to avoid the herein described, hazard or hazardous situation.</li> <li>• ...</li> <li>• ...</li> </ul>

Table of supplementary safety information symbols

The reference list below incorporates all safety information symbols used in this manual and their meaning.

Symbol	Meaning
	General warning
	Electrical hazard
	Heavy weight, avoid over exertion
	Explosive gases, explosive environment
	Harmful to life-forms
	Hot item, hot surface
	Device damage
	Inhalation of substances
	Chemical burns by corrosives
	Fragile components
	Wear laboratory coat

	Wear protective goggles
	Wear protective mask
	Wear protective gloves

#### Additional user information

Paragraphs starting with NOTE transport helpful information for working with the device/software or its supplementaries. NOTES are not related to any kind of hazard or damage (see following example).

#### NOTE

Useful tips for the easy operation of the instrument/software.



## 2.5 Product safety



Safety warnings in this manual (as described in section 2.4) serve to make the user alert and to avoid hazardous situations emanating from residual dangers by giving appropriate counter measures. However, risks to users, property and the environment can arise when the instrument is damaged, used carelessly or improperly.







### 2.5.1 General hazards

The following safety messages show hazards of general kind which may occur when handling the instrument. The user shall observe all listed counter measures in order to achieve and maintain the lowest possible level of hazard.

Additional warning messages can be found whenever actions and situations described in this manual are related to situational hazards.

  	<b>! DANGER</b>
	<p>Death by suffocation or serious poisoning by inhalation of inert gases.</p> <ul style="list-style-type: none"> <li>• Do not inhale inert gases</li> <li>• Directly withdraw released gases and gaeous substances by sufficient ventilation</li> <li>• Only operate the instrument in ventilated environments</li> <li>• Before operation, check all parts, connections and sealings involved in the gas flow for proper sealing</li> <li>• Exchange worn out or defective parts immediately</li> </ul>



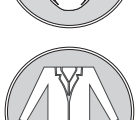





  	<p><b>! DANGER</b></p> <p>Death or serious poisoning by gases or particles due to O<sub>2</sub>-sensor or filter malfunction</p> <ul style="list-style-type: none"> <li>• Exchange defective O<sub>2</sub>-sensor immediately</li> <li>• Exchange O<sub>2</sub>-sensor regularly within the specified maintenance intervals</li> <li>• Exchange clogged filters immediately</li> <li>• Exchange filters regularly within the specified maintenance intervals</li> <li>• Dispose of filter immediately</li> </ul>
---	--



      	<p><b>! DANGER</b></p> <p>Death or serious poisoning by inhalation or incorporation of dried particles during spray process.</p> <ul style="list-style-type: none"> <li>• Wear safety goggles</li> <li>• Wear safety gloves</li> <li>• Wear a suitable protective mask</li> <li>• Wear a laboratory coat</li> <li>• Check for proper sealing before use</li> <li>• Do not inhale dried particles</li> <li>• Stop drying gas flow before opening the drying circuit</li> </ul>
--	---

	<p><b>! DANGER</b></p> <p>Death or serious poisoning by inhalation or incorporation of dried particles at recovery.</p> <ul style="list-style-type: none"> <li>• Wear safety goggles</li> <li>• Wear safety gloves</li> <li>• Wear a suitable protective mask</li> <li>• Wear a laboratory coat</li> <li>• Do not inhale dried particles</li> <li>• Stop drying gas flow before opening the drying circuit</li> <li>• Only recover particles in sufficiently ventilated flue or glove-box</li> <li>• Do not disperse the dried particles</li> <li>• Do not clean dusty parts with compressed air</li> </ul>
--	---

	<p><b>! WARNING</b></p> <p>Death or serious injuries by use in explosive environments.</p> <ul style="list-style-type: none"> <li>• Do not operate the instrument in explosive environments</li> <li>• Do not operate the instrument with explosive gas mixtures</li> <li>• Before operation, check all gas connections for correct installation</li> <li>• Directly withdraw released gases and gaseous substances by sufficient ventilation</li> </ul>
---	--





  	<p><b>! WARNING</b></p> <p>Death or serious poisoning by contact or incorporation of harmful substances at use.</p> <ul style="list-style-type: none"> <li>• Before operation, check the instrument for correct assembling</li> <li>• Before operation, inspect sealings and tubes for good condition</li> <li>• Exchange worn out or defective parts immediately</li> <li>• Exchange clogged filters immediately</li> <li>• Only operate the instrument in ventilated environments</li> <li>• Directly withdraw released gases and gaseous substances by sufficient ventilation</li> <li>• Perform a dry-run without sample material and check for gas leakages</li> </ul>
 	<p><b>! CAUTION</b></p> <p>Risk of minor poisoning by inhalation of ozone.</p> <ul style="list-style-type: none"> <li>• Directly withdraw released gases and gaseous substances by sufficient ventilation</li> </ul>
 	<p><b>! CAUTION</b></p> <p>Risk of minor or moderate burnings when handling hot parts.</p> <ul style="list-style-type: none"> <li>• Do not touch hot parts</li> <li>• Let the system cool down for some minutes after use</li> </ul>
	<p><b>! NOTICE</b></p> <p>Risk of instrument short-circuits and damage by liquids.</p> <ul style="list-style-type: none"> <li>• Do not spill liquids over the instrument or its component parts</li> <li>• Wipe off any liquids instantly</li> <li>• Place the sample vessel onto the designated reservoir-plate on top of the instrument</li> <li>• Ensure a safe positioning of the sample vessel</li> <li>• Do not move the instrument when it is loaded with liquid</li> <li>• Keep external vibrations away from the instrument</li> </ul>
	<p><b>! NOTICE</b></p> <p>Risk of instrument damage by internal overpressure.</p> <ul style="list-style-type: none"> <li>• External supply pressure must meet the system specifications</li> <li>• Exchange clogged filters immediately</li> <li>• Dispose of filter immediately</li> </ul>

 	<b>! NOTICE</b>
<p>Risk of instrument damage by wrong mains supply.</p> <ul style="list-style-type: none"> <li>• External mains supply must meet the voltage given on the type plate</li> <li>• Check for sufficient grounding</li> </ul>	



### 2.5.2 Warning labels on housing and assemblies

The following warning sticker(s) can be found on the housing or assemblies of the Mini Spray Dryer B-290 and Inert Loop B-295:

Symbol	Meaning	Location	
	Do not touch hot item, hot surface!	Label, located at the spray cylinder, B-290	
 <p style="text-align: center;"><b>ACHTUNG!</b> Vor Öffnen des Gehäuses Netzstecker ziehen!</p> <p style="text-align: center;"><b>WARNING!</b> Disconnect power supply before removing cover!</p>	See text	Sticker at the rear side, B-290	
	<p>Do not use aqueous solutions at cooling temperatures below +10°C. Freezing may cause damage in the heat exchanger.</p> <p>Keine wässrigen Lösungen bei Kühltemperaturen unter +10°C verwenden. Eisbildung kann den Wärmetauscher schädigen.</p> <p>No use soluciones acuosasa en temperaturas refrescantes debajo de +10°C. La congelacion puede causar daños al sistema.</p>	See text	Sticker/label, located on the B-295

### 2.5.3 Personal protective equipment

Always wear personal protective equipment such as protective eye goggles, protective clothing and gloves. Wear protective mask to protect from inhalation of fine particles. The personal protective equipment must meet all requirements of all data sheets for the chemicals used. These instructions are an important part of the instrument and must be made available at all times to the operating personnel at the place where the equipment is deployed. Additional protective measures can be necessary according to the applications! The user is fully responsible for choosing adequate measures!

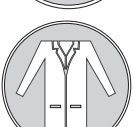
   	<b>! WARNING</b>
	<p>Serious chemical burns by corrosives.</p> <ul style="list-style-type: none"> <li>• Observe all data sheets of the used chemicals</li> <li>• Handle corrosives in well ventilated environments only</li> <li>• Always wear protective goggles</li> <li>• Always wear protective gloves</li> <li>• Always wear protective clothes</li> <li>• Do not use damaged glassware</li> <li>• Wear protective mask when working with inhalable particles</li> </ul>

#### 2.5.4 Safety elements and measures

To arrest electrostatic charges from the instrument, it is internally grounded. Electrostatic charges are to be arrested from both the product collection vessel via the external (yellow) grounding cable for all cyclones with grounding socket.

##### Heating

- Excess temperature protection against uncontrolled overheating.
- Automatic temperature control of the heater and inlet temperature.
- Heater can not be started before the closed loop is inert

##### Spraying (Pump)

- Pump can not be started before the closed loop is inert

##### Air/Gas

The system can be used in suction mode (standard) or in pressure mode. The suction procedure used in the Mini Spray Dryer B-290 produces a light negative pressure in the instrument and thus rules out, together with the inlet filter and outlet filter, a contamination of the environment through leaking from the instrumen.

Automatic processing interruption when system pressure is too low in closed mode

- Outlet filter to protect the environment contamination of fine dust particles via exhaust gas tubing

##### N2 inert gas

The Mini Spray Dryer B-290 Advanced can be used to work with organic solvent in combination with the Inert Loop B-295.

- Inertization against explosive gas mixtures
- oxygen concentration measurement (inside the Inert Loop B-295)
- pressure measurement (inside the Inert Loop B-295)

The heater and the pump stop if the oxygen level is > 6 vol.% or if the pressure level is < 10 mbar.

### Glass

- Use of inert 3.3 borosilicate glass.
- Grounded coating of the inner surface of the cyclone to prevent any electrostatic charge of the power.
- Screw couplings between glass connections to prevent glass breakage.

### Optional system configuration with Inert Loop B-295

- Overpressure leakage detection.
- Safe gas condition (< 6 % O<sub>2</sub> content) is detected and enables the regulation of the drying gas mixture via a communication cable.

## 2.6 General safety rules

### Responsibility of the operator

The head of the laboratory is responsible for training his/her personne.

The operator shall inform the manufacturer without delay of any safety-related incidents which might occur during operation of the instrument or its accessories. Legal regulations, such as local, state and federal laws applying to the instrument or its accessories must be strictly followed.

### Duty of maintenance and care

The operator is responsible for the proper condition of instrument. This includes maintenance, service and repair jobs that are performed and on schedule by authorized personnel only.

### Spare parts to be used

Use only genuine consumables and spare parts for maintenance to assure good system performance, reliability and safety. Any modifications of spare parts or assemblies are only allowed with the prior written permission of the manufacturer.

### Modifications

Modifications to the instrument are only permitted after prior consultation and with the written approval of the manufacturer. Modifications and upgrades shall only be carried out by an authorized BUCHI technical engineer. The manufacturer will decline any claim resulting from unauthorized modifications.

## 3 Technical data

This chapter introduces the reader to the instrument specifications. It contains the scope of delivery, technical data, requirements and performance data.

### 3.1 Scope of application and delivery

The Mini Spray Dryer B-290 is available in three different set-ups:

#### Mini Spray Dryer B-290 Basic

- For aqueous applications with air in 'open mode'

#### Mini Spray Dryer B-290 Acid resistant

- For acidic applications with air in 'open mode'

#### Mini Spray Dryer B-290 Advanced

- For solvent applications in combination with Inert Loop B-295
- Optional use with Dehumidifier B-296
- Accessories are solvent resistant

The scope of delivery can only be checked according to the individual delivery note and the listed order numbers.

#### NOTE

For additional information on the listed products, see [www.buchi.com](http://www.buchi.com) or contact your local dealer.

#### 3.1.1 Standard instrument



**Table 3-1: Standard instrument**

Product	Ordernumber
Mini Spray Dryer B-290 200 V	44781
Mini Spray Dryer B-290 230 V	44780
Mini Spray Dryer B-290 Advanced 200V	44700
Mini Spray Dryer B-290 Advanced 230V	44699
Mini Spray Dryer B-290 Acid resistant 200 V	11056420
Mini Spray Dryer B-290 Acid resistant 230 V	11056421

## 3.1.2 Standard accessories

**Table 3-2: Standard accessories**

Product	Ordernumber
Operation Manual:	
German	093000
English	093001
French	093002
Italian	093003
Spanish	093004
Glass assembly complete	044680
Compressed gas tube, 5 m with quick coupling, complete	046356
Silicone tube for nozzle cooling, 4 m	004139
Silicone tube (per m)	004138
Cleaning brush for nozzle	044782
Polypress tube for gas stream, 3 m	046341
Hose clamps	004236
Spray Dryer Application Support and Training (1 day training and application tests)	910040

## 3.1.3 Standard accessories with the B-290 Advanced

**Table 3-3: Standard accessories with the B-290 Advanced**

Product	Ordernumber
Lamella safety curtain	044783
Feed switch valve	044725
Spray cylinder, vertical outlet	044697
Nozzle cap, 1.4 mm	044649
Tygon tube MH2375 transparent (perm)	046314
Tygon tube F 4040 A yellow (per m)	046315

## 3.1.4 Standard accessories with the B-290 Acid resistant

**Table 3-4: Standard accessories with the B-290 Acid resistant**

Product	Ordernumber
Two-fluid nozzle acid resistant	11056320
Glass assembly acid resistant complete	11056386
Spray cylinder holder PFA coated	11056324
Cyclone metall cover PFA coated	11056327
Knurled screws PFA coated	11056325
Flange coupling PFA coated	11056326
Temperature sensor acid resistant	11056329

**Table 3-4: Standard accessories with the B-290  
Acid resistant (cont.)**

Temperature sensor support adapter	11056318
Clamp ring ID 8 mm	11056387
O-ring FPM 8×1 mm	004221
Connecting nipple PFA coated	11056328
Connecting piece PFA coated	11056334
Needle 0.7 mm titanium	11056315
Nozzle tip 0.7 mm titanium	11056317

### 3.1.5 Optional accessories

**Table 3-5: Optional accessories**

Product	Ordernumber
Inert Loop B-295 50 Hz, 200 V	044779
Inert Loop B-295 50 Hz, 230 V	044701
Inert Loop B-295 60 Hz, 200 V	046345
Inert Loop B-295 60 Hz, 230 V	046344
Dehumidifier B-296 50/60 Hz, 230 V	040188
Dehumidifier B-296 50/60 Hz, 200 V	040181
Spraychilling accessory 50/60 Hz, 230 V	040351
Spraychilling accessory 50/60 Hz, 200 V	040352
Brown glass assembly	044758
Two-fluid nozzle, complete	044698
Three-fluid nozzle, complete	046555
Three-fluid nozzle conversion kit	046556
Three-fluid nozzle acid resistant	11056971
Cylinder Insulation	040058
Remote control panel B-290	044702
Outlet filter acid resistant complete	11056333
Outlet filter, complete	044754
Inlet filter	011235
Compressed air maintenance unit	004366
Oil-free compressor, 230 V/50 Hz	027907
Oil-free compressor, 230 V/60 Hz	11055737
IQ/OQ Documentation B-290	11057023
OQ Documentation B-290	11057024

## 3.2 Technical data overview

<b>Table 3-6: Technical data Mini Spray Dryer B-290</b>	
Power consumption	max. 2900 W
Connection voltage	200–230 V ± 10 %
Frequency	50/60 Hz
Environmental conditions	for indoor use only
Temperature	5–40 °C
Altitude	up to 2000 m
Humidity	maximum relative humidity 80% for temperatures up to 31 °C decreasing linearly to 50% relative humidity at 40 °C
Evaporating capacity	1.0 l/h H <sub>2</sub> O, higher for organic solvents
Airflow	max. of 35 m <sup>3</sup> /h
Motor control	Frequency converter
Max. temperature input	220 °C
Heating capacity	2300 W
Heating control	PT-100, fuzzy logic, control accuracy ± 3 °C
Interface	Serial port RS-232 for all parameters
Spray gas	Compressed air or nitrogen/200–800 l/h, 5–8 bar
Nozzle tip diameter	0.7 mm standard, other sizes 1.4 and 2.0 mm available
Possible particle diameter range	1–25 µm
Pollution degree	2
Installation category	II
Dimensions (W×H×D)	65×110×70 cm
Weight	46 kg

<b>Table 3-7: Technical data Spray Chilling accessory</b>	
Power consumption	max. 400 W
Connection voltage	200–230 V ± 10 %
Frequency	50/60 Hz
Heating control (from B-290)	PT-100, fuzzy logic, control accuracy ± 2 °C
Interface	Serial port RS-232 for all parameters
Spray gas	Compressed air or nitrogen/200–800 l/h, 5–8 bar
Nozzle tip diameter	0.7 mm standard, other sizes 1.4 and 2.0 mm available
Possible particle diameter range	20–200 µm
Pollution degree	2
Installation category	II
Dimensions (W×H×D)	20×20×30 cm
Weight	2.4 kg
Product vessel	87 mm height, 71 mm inner Ø
Batch volume	0.3 liter



**Table 3-7: Technical data Spray Chilling accessory (cont.)**

Heating liquid	water or thermal oil (polyethyleneglycol PEG400 with low viscosity)
Heating liquid volume	1.4 liter
Max. melting point of sample	70 °C

**Table 3-8: Technical data Inert Loop B-295**

Power consumption	max. 1400 W
Connection voltage	200-230 V $\pm$ 10 %
Frequency	50/60 Hz
Min. outlet temperature	down to -20 °C
Rate of cooling	800 W at -10 °C
Dimensions (W×H×D)	60×70×84.5 cm
Weight	88 kg

**Table 3-9: Technical data Dehumidifier B-296**

Power consumption	700 W
Connection voltage	200/230 V $\pm$ 10 %
Frequency	50/60 Hz
Min. outlet temperature	+ 0 °C
Rate of cooling	600 W at 0 °C
Dimensions (W×H×D)	35×40×60 cm
Weight	36 kg

### 3.3 Materials used

**Table 3-10: Materials used**

Component	Material designation	Material code
Glass assembly	3.3 borosilicate glass	
Nozzle/heater/connection piece	Stainless steel	1.4301/1.4305
Seal of product collection vessel	FPM	
Seal cyclone/cylinder	Silicone	
Preheat exchanger Inert Loop B-295	Stainless steel	1.4301
Polypress tube	EPDM	
Product feed tube	Silicone and tygon	
Acid resistant coated metal	PFA (perfluoroalkoxy polymer)	
Acid resistant metal	titanium, Alloy 600	
Metal parts Mini Spray Dryer B-290 acid resistant	PFA-coated	

## 4 Description of function

This chapter explains the basic working principle of the Mini Spray Dryer B-290 Basic (open mode only) and the Mini Spray Dryer B-290 Advanced (for closed mode operation). It also shows how the instruments are structured and provides a general functional description of the assemblies.

### 4.1 Functional principle of the drying gas

The Mini Spray Dryer B-290 operates according to a co-current drying gas (e.g. air in open mode) and product stream. This means that sprayed product and hot gas have the same flow direction from downward.

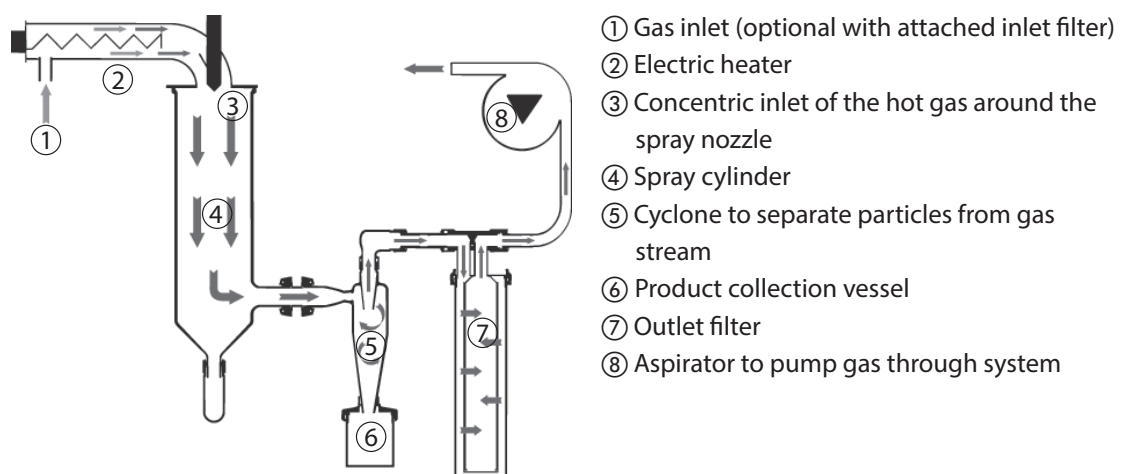

Fig. 4.1: Functional principle of the drying air

### 4.2 Functional principle of the sample feed and dispersion

The Mini Spray Dryer has an integrated two-fluid nozzle: Compressed gas (normally air or  $N_2$ ) is used to disperse the liquid body into fine droplets which are subsequently dried in the cylinder.

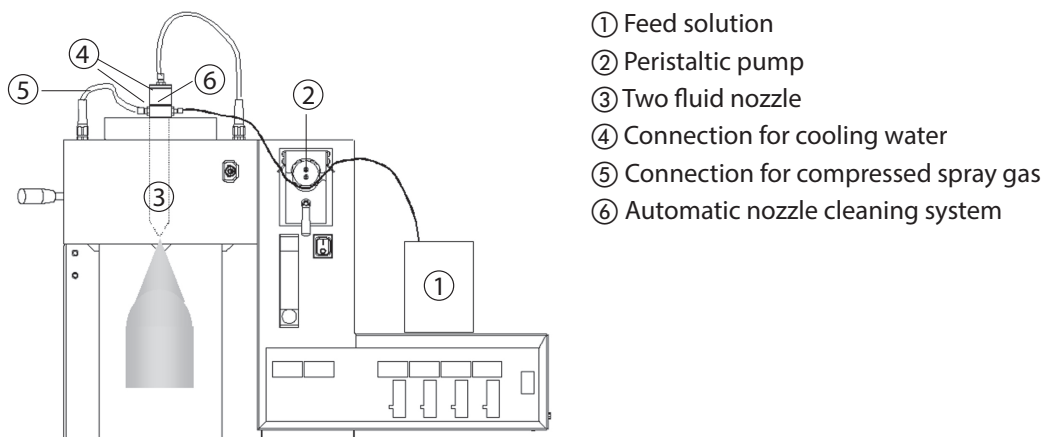

Fig. 4.2: Functional principle of the sample feed and dispersion

#### Spraying nozzle

The nozzle consists of the nozzle tip with a 0.7 mm diameter hole and the nozzle cap (1.4 or 1.5 mm in diameter). This geometry results in a mixing of fluid body and gas.

The nozzle cap has an inserted ruby stone with a precise opening and sharp edges to guarantee a precise and reproducible spray cone.

The smaller nozzle cap of 1.4 mm diameter leads to a lower consumption of spray gas, as the concentric ring around the nozzle is smaller. This nozzle is recommended when nitrogen is used to minimize operating costs. The larger nozzle cap opening of 1.5 mm is typically used when air serves as spraying gas, as this design is more robust regarding concentric alignment to form a vertical and uniform spray cone.

Optional nozzle sets with 1.4 mm or 2.0 mm nozzle tip diameter are available to increase the droplet size and/or to spray more viscous samples or dispersions.

### 4.3 Outlet filter

The outlet filter, consisting of a polyester textile, prevents environmental pollution and the possible corrosion of the aspirator by very fine particles which cannot be separated in the cyclone. It can be washed by hand or machine. All needed connections are included.

The second filter included is made of a PTFE membrane. By counter-pulsing the filter with pressurised air, some of the collected particles can be recovered resulting in a higher yield (see chapter 6.6).

The manometer indicates the system pressure in front of the filter. With a clean filter, the corresponding pressure drop is marked.

### 4.4 Inert Loop B-295

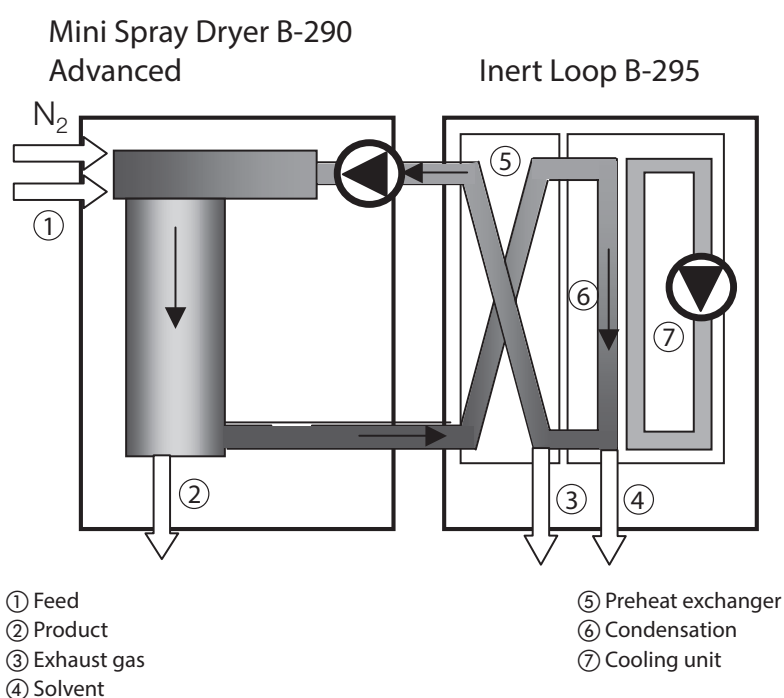

Fig. 4.3: Combined system of the Mini Spray Dryer B-290 and Inert Loop B-295

The Inert Loop B-295 is an accessory to enable the safe use of organic solvent in a closed loop. The inert gas is loaded with solvent from the spray drying process. After precooling in a preheat exchanger, the solvent is condensed in a refrigerator and collected in a closed bottle. The cleaned gas stream is preheated in the preheat exchanger and flows back to the Mini Spray Dryer B-290 Advanced.

## 4.5 Dehumidifier B-296

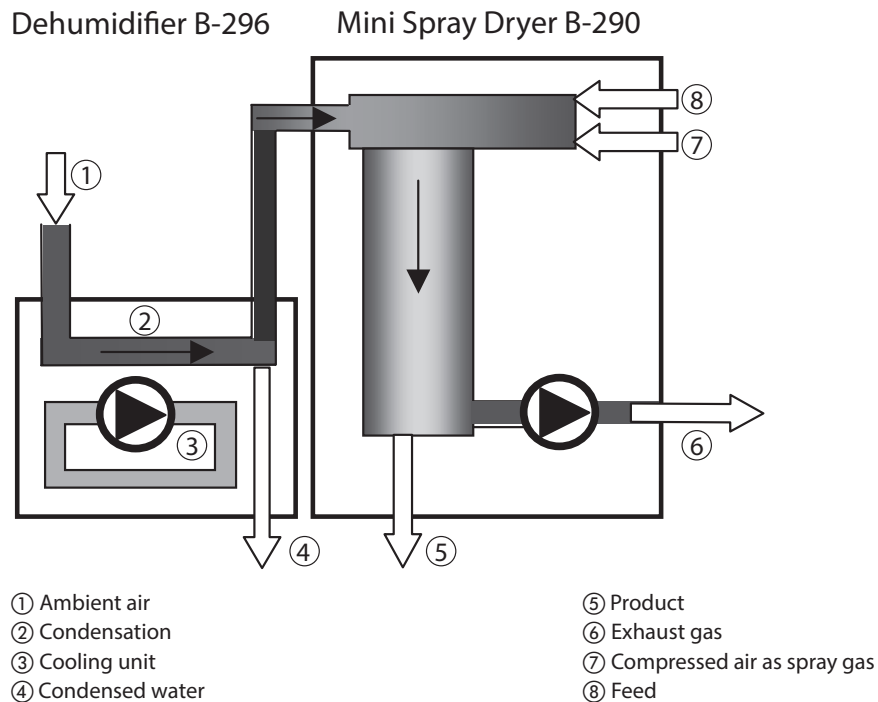

Fig. 4.4: Open loop Mini Spray Dryer B-290 with Dehumidifier B-296 for inlet air conditioning

Use as inlet air conditioning

The Dehumidifier B-296 is an accessory to enable a drying under constant and reproducible humidity conditions cooling to a dew point of 3–5 °C.

The drying air is passing the refrigerator of the Dehumidifier B-296. The humidity in the ambient air condenses in the refrigerator and is collected in a closed bottle.

The dry air is then heated up by the heater of the Mini Spray Dryer B-29.

Use in the closed mode

The inert gas is loaded with water-solvent mixture from the spray drying process in an external preheat exchanger.

The solvent condenses in the Dehumidifier B-296 and is collected in a receiving vessel.

## 4.6 Spray chilling accessory

During spray chilling a hot melt is dispersed into a cold gas stream. The droplets are solidified into particles and are separated. The matrix substance and the active ingredients are heated above the melting point. Highest melting point is 70 °C. The nozzle is also heated to prevent any blocking. No additional thermostat is required, as the existing heating control and peristaltic pump in the instrument are used. If the sample has a low melting point, then the inlet air is cooled to increase the temperature gradient. If lower temperatures than 10 °C (provided by the B-296) are used, e.g. for hard fats, the inlet air can be cooled to -5 °C by using a specially developed refrigeration unit (please contact your local distributor).

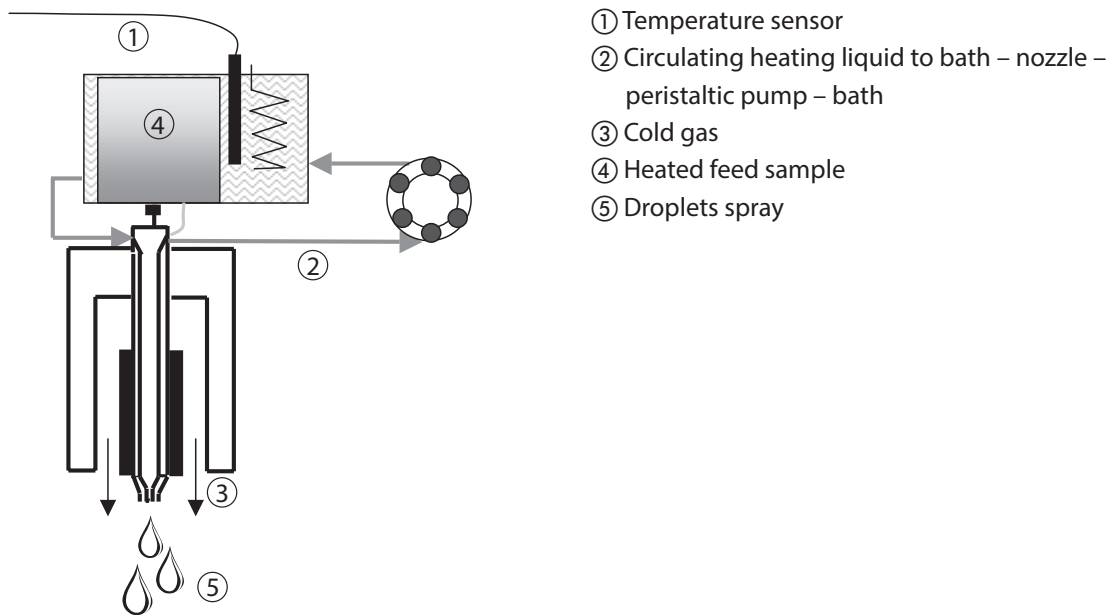

Fig. 4.5: Functional principle of the sample feed and dispersion

## 4.7 Connected accessories to the Mini Spray Dryer B-290

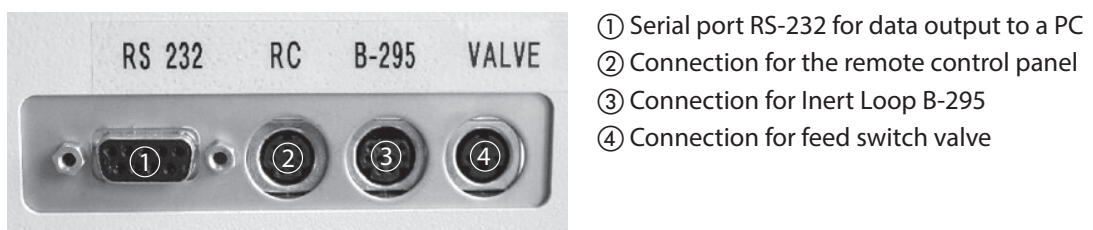

Fig. 4.6: Rear connections of the Mini Spray Dryer B-290

## 4.7.1 Feed switch valve and remote control panel



Fig. 4.7: Feed switch valve and remote control panel

The remote control panel enables an easy operation even within a closed fume hood. The flow meter for the spraying gas is the only parameter which cannot be adjusted via the remote control panel.

The feed switch valve is a useful tool together with the remote control panel. During the start and end of the spray process, the feeding tube has to be moved from pure solvent to product solution and vice versa. This can be automated by means of the feed switch valve. A Y-piece is inserted between peristaltic pump and feed switch valve.

## 4.7.2 Printer or PC for data output via RS-232 serial port

The Mini Spray Dryer B-290 is supplied with a standard protocol for data readout. This is of special importance if the system is qualified and underlies special regulations.

The connection starts as soon as the heater is switched on.

The transmission rate is 2400 Baud/s, Parity: No.

The parameters are sent out every 30 seconds as an ASCII-Code, separated by a TAB (ASCII 09) and ended with a RETURN (ASCII 0D). They can be read out e.g. via the program "HyperTerminal" included in the Microsoft package.

The source is defined as follows:

No.	Information	Type	Unit
1	Time since mains on	integer	s
2	Current temperature inlet	integer	°C
3	Current temperature outlet	integer	°C
4	Heater on/off	0/1	
5	Set temperature inlet	integer	°C
6	Aspirator on/off	0/1	
7	Aspirator rotation speed	integer	%
8	Pump on/off	0/1	
9	Pump rotation speed	integer	%
10	Feed switch valve	1/2	
11	ConnectionInertLoopB-295no/yes	0/1	
12	Oxygen high	0/1	
13	Pressure low	0/1	
14	Error message	integer	

## 5 Putting into operation

This chapter describes how the instrument is installed and gives instructions on initial startup.

### NOTE

Inspect the instrument for damages during unpacking. If necessary, prepare a status report immediately to inform the postal company, railway company or transportation company.





Keep the original packaging for future transportation.

### 5.1 Installation site

Put the instrument on a stable, horizontal surface. Consider the maximum product dimensions and weight and the operation height of 1.30 meters for spray chilling applications. Make sure that you can comfortably reach the instrument.



Installation on a mobile trolley is also possible. Obtain the environmental conditions as described in section 3.2, technical data.

Put the instrument on a stable, horizontal base.

 	<p><b>Warning</b></p> <p>Death or serious injuries by use in explosive environments.</p> <ul style="list-style-type: none"> <li>• Do not operate the instrument in explosive environments</li> <li>• Do not operate the instrument with explosive gas mixtures without inertization</li> <li>• Before operation, check all gas connections for correct installation</li> <li>• Directly withdraw released gases and gaseous substances by sufficient ventilation</li> </ul>
 	<p><b>Caution</b></p> <p>Risk of minor or moderate injury by heavy weight of the instrument.</p> <ul style="list-style-type: none"> <li>• Consult a second person to transport the instrument</li> <li>• Do not tilt or drop the instrument</li> <li>• Place the instrument on a stable, even and vibration-free surface</li> <li>• Keep limbs out of crushing zone</li> <li>• Lift the device at the right and left bottom reaching areas for the hands</li> </ul>

### 5.2 Electrical connections

The Mini Spray Dryer B-290 is aimed to be installed mobile and is and is shipped with a flexible power cord. After the installation, an electrical safety test is recommended to verify a safe system condition such as sufficient grounding.

 	<p><b>NOTICE</b></p> <p>Risk of instrument damage by wrong mains supply.</p> <ul style="list-style-type: none"> <li>• External mains supply must meet the voltage given on the type plate</li> <li>• Check for sufficient grounding</li> </ul>
--	--

**NOTE**

To cut the power in case of an emergency by unplugging, the instruments or any other items must not block the mains plug! External connections and extension lines must be provided with a grounded conductor lead (3-pole couplings, cord or plug equipment). All used power cords must meet the input power requirements.

Demands on the mains circuit

The mains circuit must

- provide the voltage that is given on the type plate of the instrument.
- be able to handle the load of the connected instrument(s).
- be equipped with adequate fusing and electrical safety measures, in particular proper grounding.

**NOTE**

Additional electrical safety measures such as residual current breakers may be necessary to meet local laws and regulation!

External power switches (e.g. emergency stop switches) must meet IEC 60947-1 and IEC 60947-3 requirements. Such devices must be clearly labeled and accessible at any time.

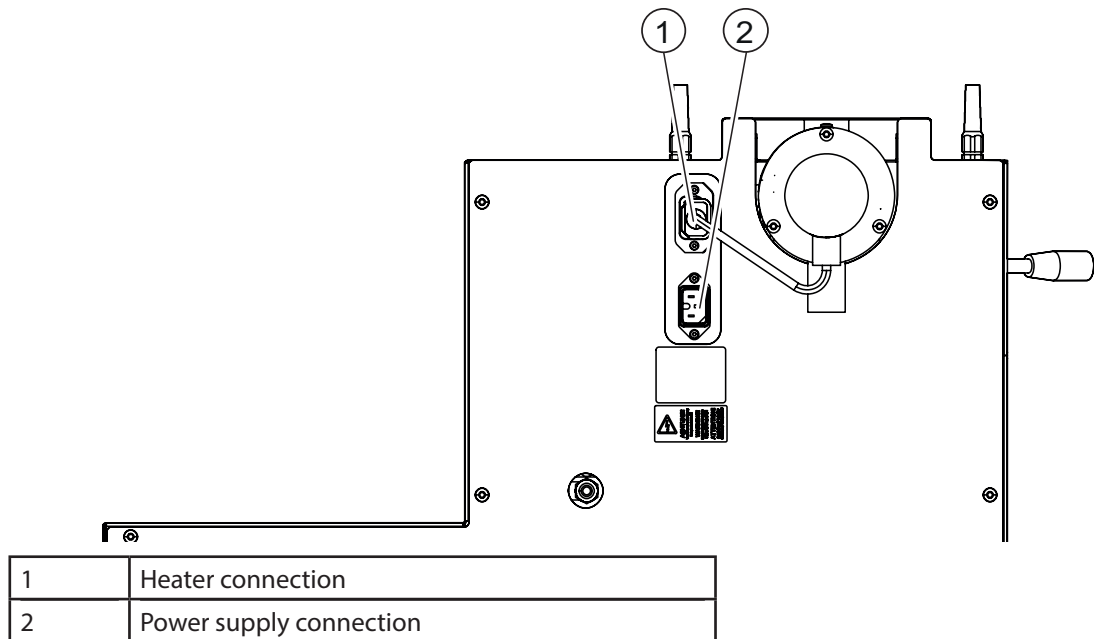



### 5.3 Installing the compressed air maintenance unit and compressor (optional)

To ensure the Mini Spray Dryer B-290 achieves an optimal atomization performance, the supply of compressed air with a pressure of 5–8 bar is necessary. The compressed air must be dried and free of impurities (contamination of the product through impure air). If this is not guaranteed, we recommend the use of a WILKERSON maintenance unit.

	<b>Notice</b>
	<p>Risk of instrument damage by internal overpressure.</p> <ul style="list-style-type: none"> <li>• External supply pressure must meet the system specifications</li> <li>• Exchange clogged or defective filters immediately</li> <li>• Dispose of clogged or defective filter immediately</li> </ul>

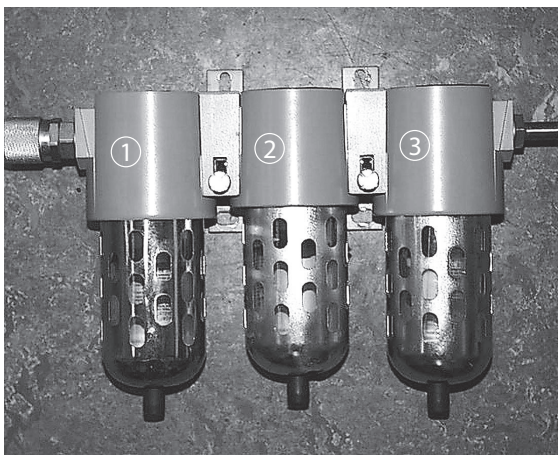

- ① Activated charcoal filter
- ② Filter
- ③ Water separator

Fig. 5.1: Compressed air maintenance unit

If there is no compressed air plant available, the compressed air can be taken from an oil-free air compressor with an output of 5–8 bar as require.

## 5.4 Installing the glass assembly

	<b>! CAUTION</b>
	<p>Risk of minor or moderate cuts by sharp edges.</p> <ul style="list-style-type: none"> <li>• Do not touch defective or broken glassware with bare hands</li> <li>• Do not touch thin metal edges</li> </ul>

To install the spray cylinder, proceed as follows:



- Screw the seal holder ② on the instrument using the three knurled screws.
- Connect the separation flask ④ to the spray cylinder ③ by closing the screw connection (SVL 42) tightly.
- Screw the connection piece ⑥ on the cylinder outlet flange with the left flange screw joint ⑦. The connection is sealed with a Viton o-ring.
- To mount the cylinder on the instrument, hold the glass in the upper flange around the nozzle and insert the connection piece into the support element ⑧.
- Open the fixation ⑤.
- Press the glass flange on the above seal.
- Push the lever ① carefully on the left side, so that the flange of the cylinder is held firmly.
- Close the fixation ⑤.

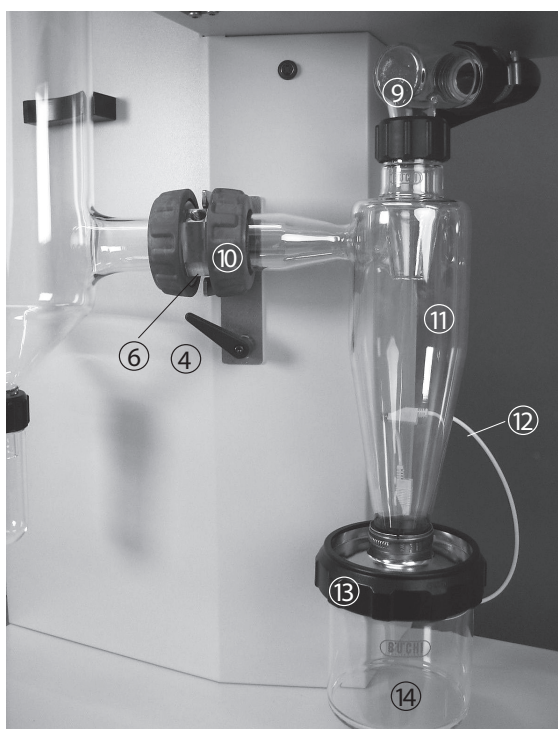

- Attach the cyclone ⑪ together with the product collection vessel ⑭ to the connection piece ⑥ with a second flange screw joint ⑩.
- Screw the glass elbow ⑨ onto the top of the cyclone.
- Connect the grounding cable ⑫ to the cover of the product collection vessel ⑬ and to the housing to minimize the electrostatic charge of the powder.



Fig. 5.2: Installing the glass assembly

- Connect the outlet temperature sensor (15) to the plug in the housing.
- Insert the outlet temperature sensor into the connection piece (6) and screw it in. A metallic ring and O-ring is inserted to seal the probe.
- Close all connections tightly.

## 5.5 Installing the spraying nozzle

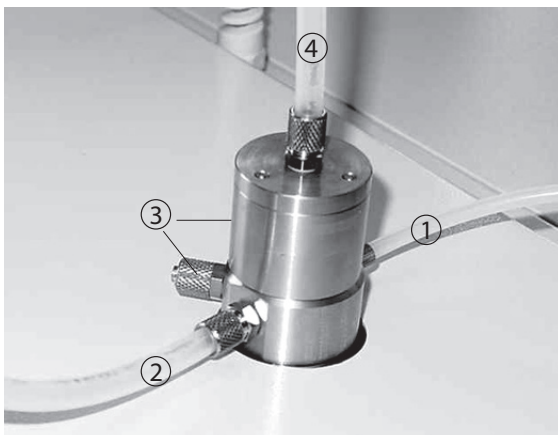

Fig. 5.3: Installing the spraying nozzle

- Insert the nozzle into the heater element at the top of the instrument.
- The two fluid spraying nozzle has a connection for the feeding tube (1), a connection for the pressurized air or nitrogen (2) and two connections (3) for an optional cooling/heating with an external thermostat. The top connection (4) is for the implemented pneumatic nozzle cleaning; a needle pushes through the nozzle and prevents clogging.

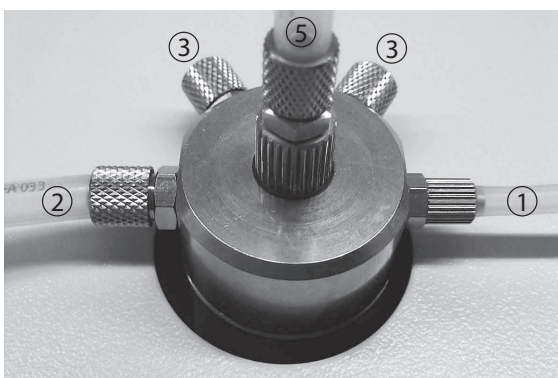



Fig. 5.4: Installing the spraying nozzle

The three fluid nozzle has a second feed supply (5) instead of the nozzle cleaning. The three fluid nozzle has two connections for two feeding tubes. An external peristaltic pump has to be mounted for the second feed supply.

## 5.6 Installing the filters

	<b>Notice</b>
	<p>Risk of instrument damage by internal overpressure.</p> <ul style="list-style-type: none"> <li>• External supply pressure must meet the system specifications</li> <li>• Exchange clogged or defective filters immediately</li> <li>• Dispose of clogged or defective filters immediately</li> </ul>

### 5.6.1 Inlet filter installation

#### Use

Pre-filtering of environmental air to keep most impurities and particles away from the spray drying process.



Fig. 5.5: Installing the inlet filter

To install the inlet filter directly connect it to the air inlet of the heater.

### 5.6.2 Outlet filter installation

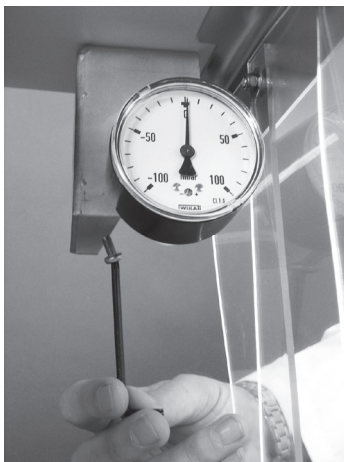

Fig. 5.6: Installing the outlet filter

- Screw the support angle to the bottom side of the panel.
- Mount the filter directly.
- Install the connecting tubing between cyclone and filter with an SVL 42.



- Unscrew all screw caps of the tubing at the filter head ① and unhook the complete filter from the holder.
- Unscrew the screw cap ② and pull off the filter housing glass. Remove the sealing ring.

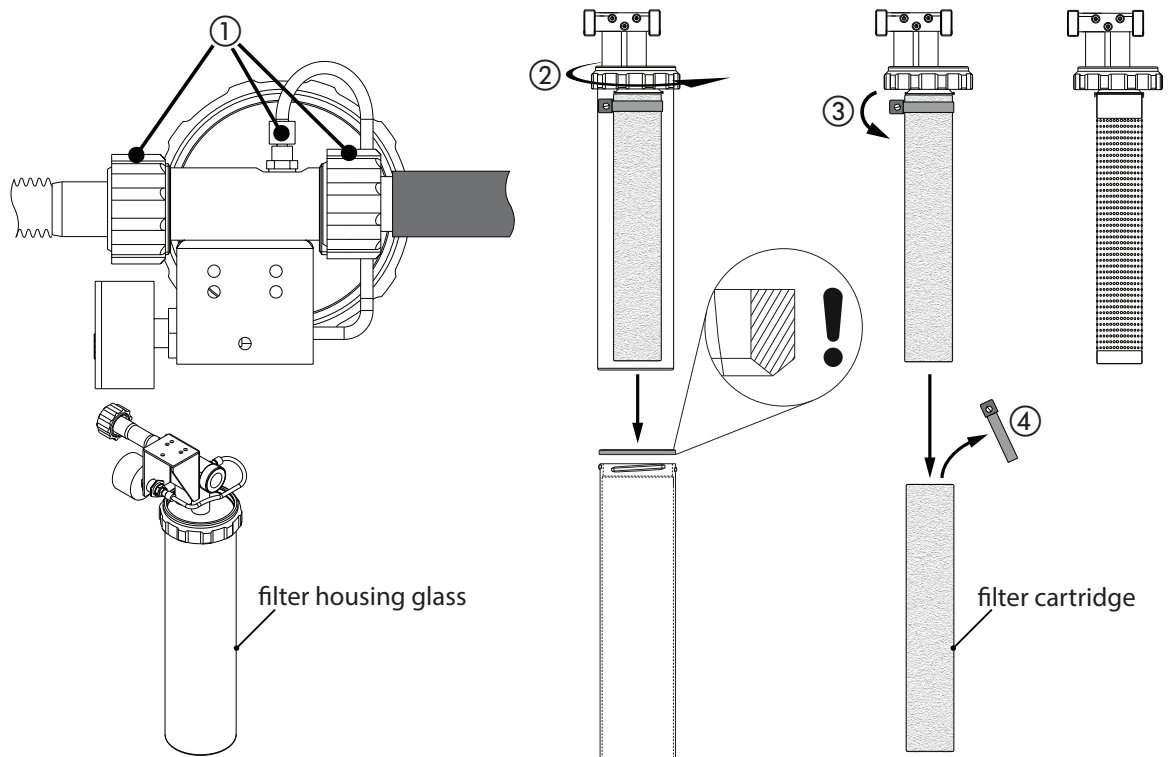

Fig. 5.7: Outlet filter installation

- Unscrew the hose clamp ③ and pull off the filter cartridge.
- Remove the hose clamp ④ from the filter cartridge.

➔ Wash the polyester filter manually or in a laboratory washing machine. Use standard soap detergents for cleaning.

For installation proceed in reverse order. Mind the correct mounting direction of the sealing ring (order no. 040471) at the filter housing glass!

#### NOTE

The flange screw coupling made of aluminum (order no. 048539) is recommended for the use of outlet temperatures higher than 80 °C for better sealing performance compared to the polymer (POM) flange (order no. 034139).

## 5.6.3 PTFE filter membrane installation

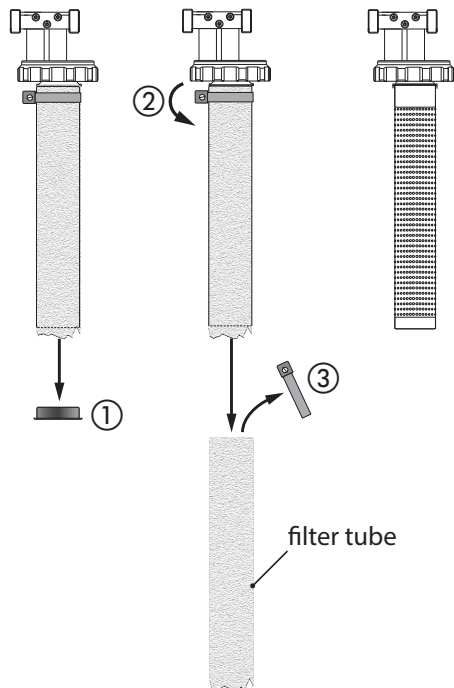

Fig. 5.8: Outlet filter membrane (PTFE) installation

- Pull out the end-cap ① of the filter membrane.
- Unscrew the hose clamp ② and pull off the filter membrane.
- Remove the hose clamp ③ from the filter tube.

➔ Gently flush the PTFE filter membrane manually only. Use standard soap detergents for cleaning.

It is recommended to exchange the filter membrane regularly.

For installation proceed in reverse order.

Wrap the end of the filter tube into the filter carrier and push in the end-cap (see Fig. 5.7).

**NOTE**

Make sure the end-cap properly seals the filter carrier and the filter membrane! This is essential for effective filtering.

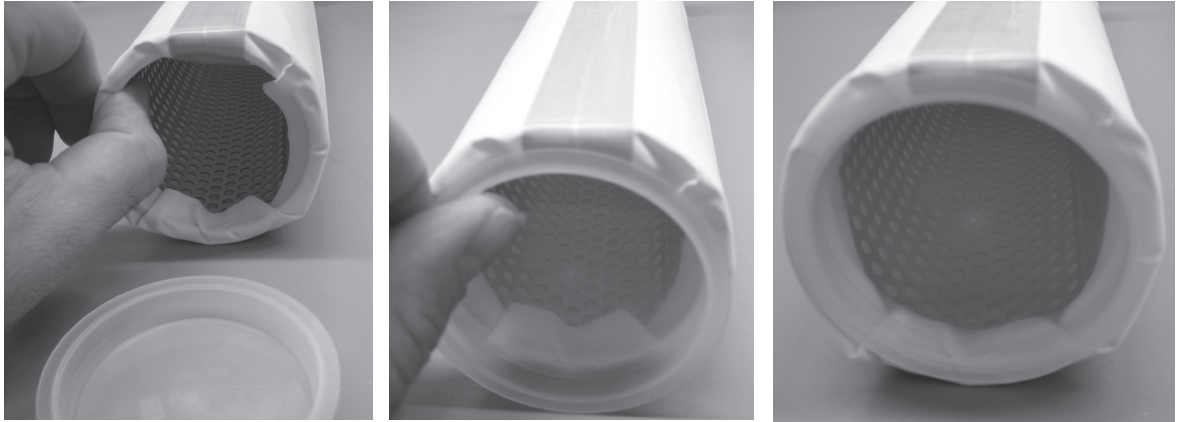

Fig. 5.9: Installing the end-cap to seal the filter tube

Mind the correct mounting direction of the sealing ring (order no. 040471) at the filter housing glass!

**NOTE**

The flange screw coupling made of aluminum (order no. 048539) is recommended for the use of outlet temperatures higher than 80 °C for better sealing performance compared to the polymer (POM) flange (order no. 034139).

#### 5.6.4 Cleaning filter installation

Use

- When connected to the air inlet at the heater the filter works as an inlet cleaning filter to remove even finest particles from the drying air.
- When connected to the process air outlet tube the filter works as a safety element to hold back finest product residues from the environmental air.



Fig. 5.10: Housing with filter cartridge

Installation as inlet cleaning filter

Install the filter between the heater air inlet and the inlet filter. The filter cascade will ensure maximal particle free air in standard environment.

Installation as safety outlet filter

Install the filter between the outlet filter and the Aspirator. This will hold back finest particles from the Aspirator and the environment e.g. the laboratory air.



Fig. 5.11: Cleaning filter installed with stop cock

## 5.7 Adjusting the peristaltic pump bed and choosing the feeding tube

The pump bed of the peristaltic pump is adjusted ex works to the standard silicone tube. If different tubes, e.g. the tygon tubes for organic solvents, are used, adjust the pump bed with an allen key. Connect an adapter piece as a tube stopper between two feeding tubes to prevent slipping in the peristaltic pump.

### Adjusting the peristaltic pump bed

	<b>Notice</b>
	<p>Risk of instrument short-circuits and damage by liquids.</p> <ul style="list-style-type: none"> <li>• Do not spill liquids over the instrument or its component parts</li> <li>• Wipe off any liquids instantly</li> <li>• Place the sample vessel onto the designated reservoir-plate on top of the instrument</li> <li>• Ensure a safe positioning of the sample vessel</li> <li>• Do not move the instrument when it is loaded with liquid</li> <li>• Keep external vibrations away from the instrument</li> </ul>



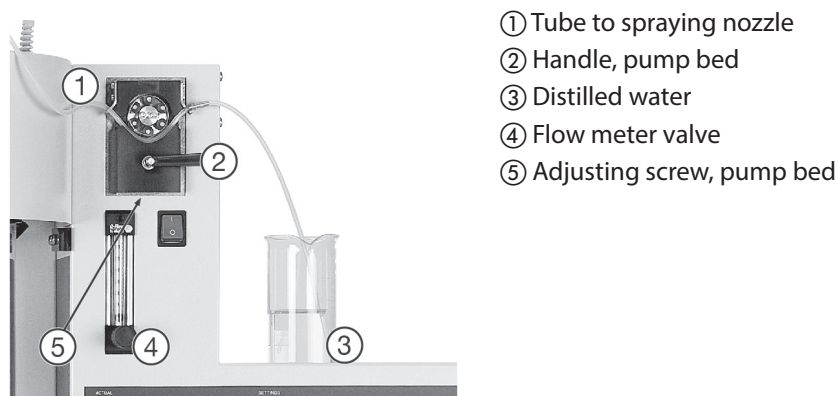

Fig. 5.12: Pump bed adjustment

1. Remove spraying nozzle from the Mini Sprayer B-290 and hold spraying nozzle into a suitable container.
2. Insert tube ① in to the pump bed.
3. Put tube on the suction side into distilled water ③.
4. Close pump bed with handle ②.
5. Unscrew adjusting screw ⑤ 1 turn.
6. Open the flow meter valve ④ to 40 mm.

**NOTE**

Distilled water ③ is now flowing through the tubing without the feeding pump running.

7. Turn the adjusting screw ⑤ in until the water flow stops.
8. Turn adjusting screw  $\frac{1}{4}$  further in.
9. Close flow meter valve to 0 mm.
10. Install spraying nozzle back into the Mini Sprayer B-290.

Choose the feeding tube according to the following table. For short processes, even unsuitable tubes can be used, as swelling takes some time.

**Table 5-1: Choosing the feeding tube**

Solvent	Silicone tube	Tygon MH 2375	Tygon F 4040 A
Methanol	suitable	suitable	suitable
Ethanol	suitable	suitable	suitable
Acetone	unsuitable	suitable	unsuitable
Toluene	unsuitable	unsuitable	unsuitable
Isopropanol	suitable	suitable	suitable
Chloroform	unsuitable	unsuitable	unsuitable
Dichloro methane	unsuitable	unsuitable	unsuitable
THF	unsuitable	unsuitable	unsuitable
Ethylacetate	unsuitable	suitable	unsuitable
Hexane	unsuitable	unsuitable	suitable

## 5.8 Tubing installation

The Mini Spray Dryer B-290 needs compressed gas for the two-fluid nozzle and the nozzle cleaner between 5 and 8 bar. Therefore, the air or nitrogen is connected on the rear of the instrument via a quick coupling.

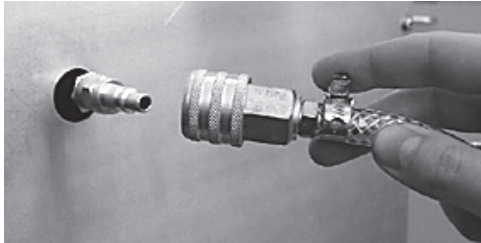

Fig. 5.13: Quick coupling rear side

The Mini Spray Dryer B-290 can be used in an open or closed mode. The open mode is set in the suction mode as a standard. However, if the exhaust gas is aggressive and could lead to a corrosion of the aspirator, the instrument can also be run in a pressure mode. This mode leads to a higher noise emission.

### NOTE

Risk of instrument malfunction when the instrument is operated with bent hoses.

- Always inspect the instrument for bends or kinks in hoses and eliminate them prior to operation.
- Exchange hoses with signs of mechanical stress such as small cracks and blind spots at the surface immediately.

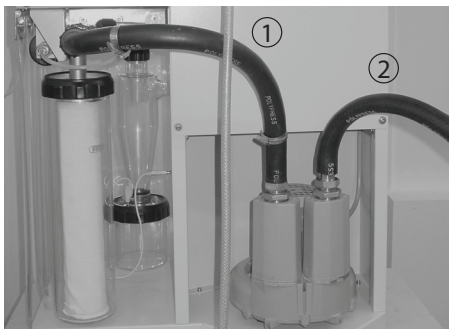

- ① Tubing between cyclone respectively filter and aspirator
- ② Exhaust tube

Fig. 5.14: Open mode set-up in suction mode

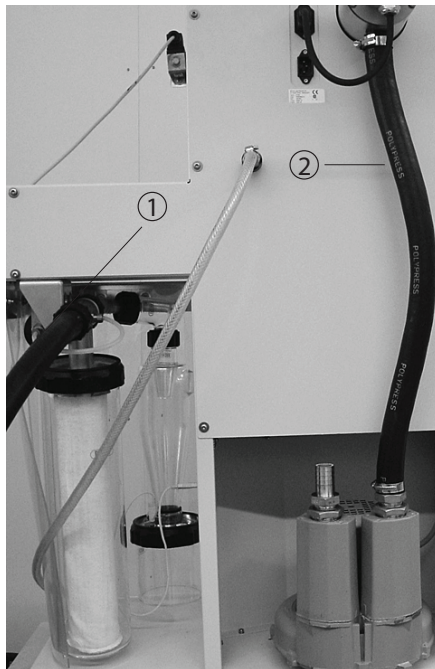

- ① Exhaust tube of cyclone or filter, respectively
- ② Tubing between aspirator and heater

Fig. 5.15: Open mode set-up in pressure mode

## 5.9 Installing the compressor

### Use

For the spray process compressed air or gas is necessary. If no compressed air supply is available in the laboratory the compressor can be installed instead.

### Installation

- Place it in a dry, dust free and well tempered room with appropriate ventilation.
- Follow the compressors manual to install the device.
- Connect the outlet of the compressor to the compressed air inlet of the Mini Spry Dryer B-290.

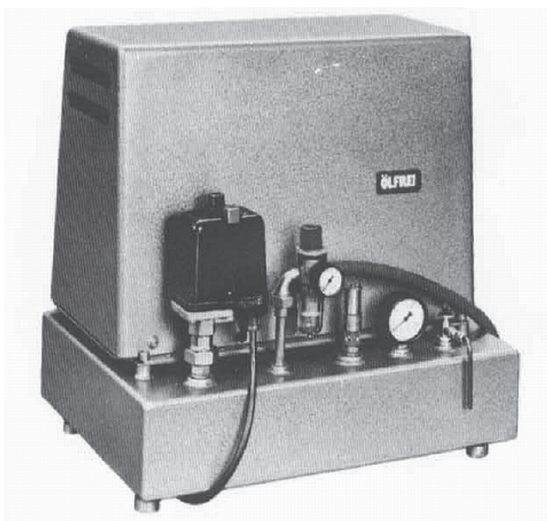

Fig. 5.16: Oil- and dust-free air compressor

### NOTE

Set the compressor to 6 bar output pressure to achieve recommended standard spray conditions.

## 5.10 Quick hose couplings

### Use

For fast and reliable connecting/disconnecting of polypress tubes e.g. the tubing of Inert Loop B-295 and Dehumidifier B-296.



### Installation

- Cut the polypress tube with a sharp knife or a special tube cutter into two halves with a clean cut. The tube ends must be straight!
- Slip one hose clamp over each tube end.
- Use one male and one female coupling adapter and install them at the tube ends.
- Secure the coupling adapters with the hose clamps.
- Test all tubes and connectors for tightness prior use!



Fig. 5.17: Quick hose couplings

## 5.11 Installing the Inert Loop B-295

  	<p><b>⚠ Danger</b></p> <p>Death or serious poisoning by gases or particles due to O<sub>2</sub>-sensor or filter malfunction</p> <ul style="list-style-type: none"> <li>• Exchange defective O<sub>2</sub>-sensor immediately</li> <li>• Exchange O<sub>2</sub>-sensor regularly within the specified maintenance intervals</li> <li>• Exchange clogged filters immediately</li> <li>• Exchange filters regularly within the specified maintenance intervals</li> <li>• Dispose of clogged or defective filters immediately</li> </ul>
---	--

	<p><b>Warning</b></p> <p>Death or serious poisoning by contact or incorporation of harmful substances at use.</p> <ul style="list-style-type: none"> <li>• Before operation, check the instrument for correct assembling</li> <li>• Before operation, inspect sealings and tubes for good condition</li> <li>• Exchange worn out or defective parts immediately</li> <li>• Exchange clogged filters immediately</li> <li>• Only operate the instrument in ventilated environments</li> <li>• Directly withdraw released gases and gaseous substances by sufficient ventilatio.</li> <li>• Perform a dry-run without sample material and check for gas leakages</li> </ul>
---	---



Fig. 5.18: Inert Loop B-295

The Inert Loop B-295 has wheels and can be placed next to the Mini Spray Dryer B-290. Moreover it can be used as a trolley if the instrument has been purchased in 2011 or later.

Connect the system to the mains supply with the power cord.

Connect the two instruments with the communication cable to ensure their safe operation. The tubing is described below.



Fig. 5.19: Mini Spray Dryer B-290 Advanced with Inert Loop B-295 as trolley

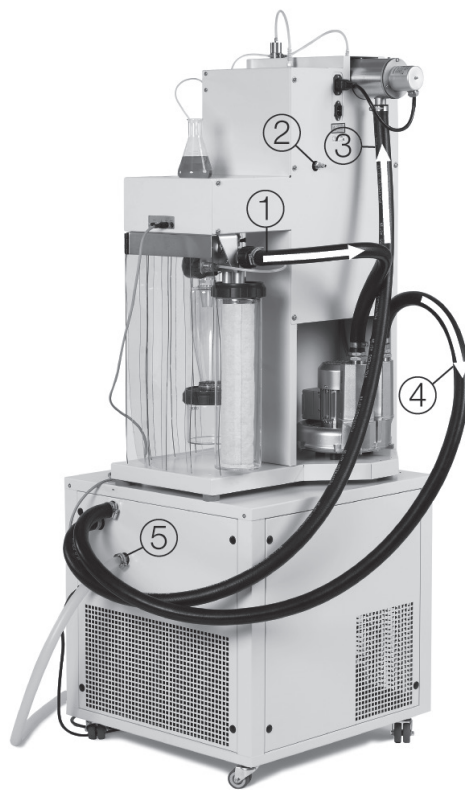

The Inert Loop B-295 has a sideward hose connection for the exhaust gas. Due to the constant feeding with nitrogen, a certain amount of it is permanently leaving the system through this outlet tube. If air is sucked in through the tube, this is an indication that the closed loop is not tight.

- ① Tubing between outlet filter and aspirator inlet
- ② Nitrogen inlet
- ③ Tubing between heater inlet and B-295 outlet
- ④ Tubing between aspirator outlet and B-295 inlet
- ⑤ Exhaust gas (nitrogen) outlet tube

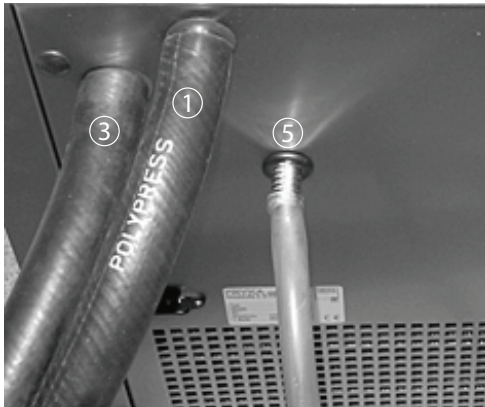

Fig. 5.20: Tubing installation for closed mode operation with Mini Spray Dryer B-290 Advanced and Inert Loop B-295



### 5.12 Dehumidifier B-296 and Inert Loop B-295 combination

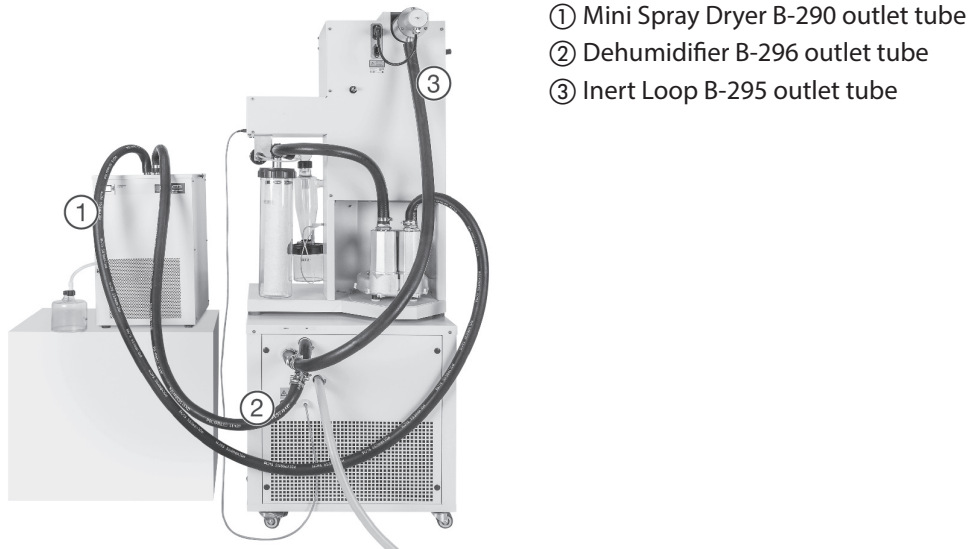

Fig. 5.21: Tube connections B-290, B-296 and B-295

- Connect the Mini Spray Dryer B-290 outlet tube ① with the inlet of the Dehumidifier B-296
- Connect the Dehumidifier B-296 outlet tube ② to the Inert Loop B-295 inlet.
- Connect the outlet ③ of the Inert Loop B-295 to the Mini Spray Dryer B-290.

### 5.13 Installing the Dehumidifier B-296

#### NOTE

Disconnect the display from the front side and insert a LR 44 battery in the display.

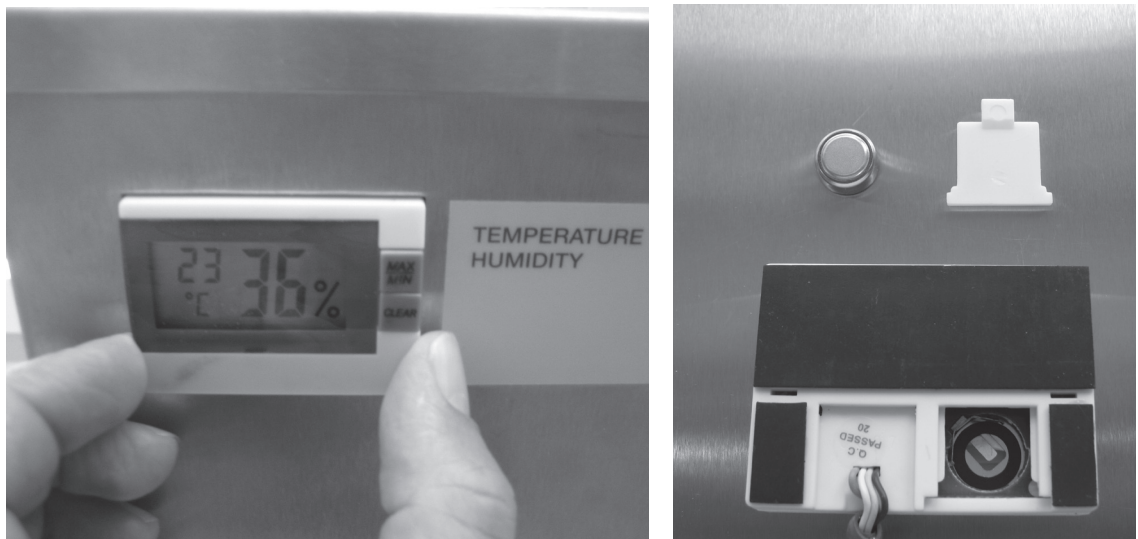

Fig. 5.22: Installation of the display

Used as inlet air conditioning system

Installation steps:

1. Place the Dehumidifier B-296 next to the Mini Spray Dryer B-290.
2. Connect the tubing ① from the outlet (labelled on the enclosure) of the Dehumidifier B-296 to the gas inlet of the Mini Spray Dryer B-290 heater.
3. Use hose clamps to fix the tubing.
4. Connect the power cord to the mains. The device can now be switched on.

① Dehumidifier B-296 outlet tube



Fig. 5.23: Tubing between the Mini Spray Dryer B-290 and the Dehumidifier B-296

Used in the closed mode

When mixtures of organic solvents and water (with less than 50 % solvents) are being processed in 'closed loop' configuration, the use of the Dehumidifier B-296 is highly recommended. The cooling temperature is fixed to 0 °C.



① Inlet tubing B-296

② Outlet tubing B-296

Fig. 5.24: Tubing between the preheat exchanger and the Mini Spray Dryer B-290

Installation steps:

1. Place the Dehumidifier B-296 next to the Mini Spray Dryer B-290.
2. Connect the tubing ② from the outlet (labelled on the enclosure) of the Dehumidifier B-296 to the gas inlet of the Mini Spray Dryer B-290.
3. Connect the tubing ① from the Mini Spray Dryer B-290 outlet to the inlet of the Dehumidifier B-296 (labelled on the enclosure).
4. Use hose clamps to fix all Polypress tubings.
5. Connect the power cord to the mains. The device can now be switched on.



## NOTE

See section 7.6 for information about the cleaning procedure of the Dehumidifier B-296.

## 5.14 Installing the Spray Chilling Accessory

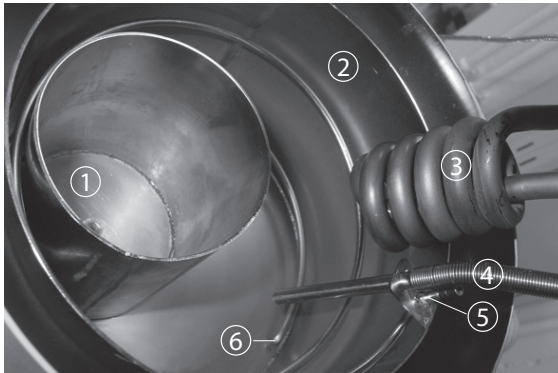

- ① Product feed vessel
- ② Heating bath
- ③ Heater

- Mount the complete bath ② on the top of the Mini Spray Dryer B-290.
- Use the knurled screws to fix the spray chilling accessory on the Mini Spray Dryer B-290 cover panel. Plug in the heater ③ of the spray chilling accessory instead of the standard heater of the Mini Spray Dryer B-290.
- Connect the long temperature sensor ④ instead of the standard outlet temperature sensor to the electrical plug and put the temperature sensor into the holder on top of the heating bath.

- ④ Temperature sensor
- ⑤ Capillary inlet
- ⑥ Capillary outlet

Fig. 5.25: Spray Chilling Accessory

## NOTE

The nozzle tip 1.4 mm with nozzle cap 2.0 mm are recommended to increase the droplet size and if clogging occurs with the standard 0.7 mm nozzle. The resulting particle size is typically in the order of the droplet size.

Open suction mode installation with the Dehumidifier B-296 to pre-cool the inlet air is recommended.

A slight negative pressure in the spray chamber forces the melted sample feed to enter the nozzle after opening the feed valve.

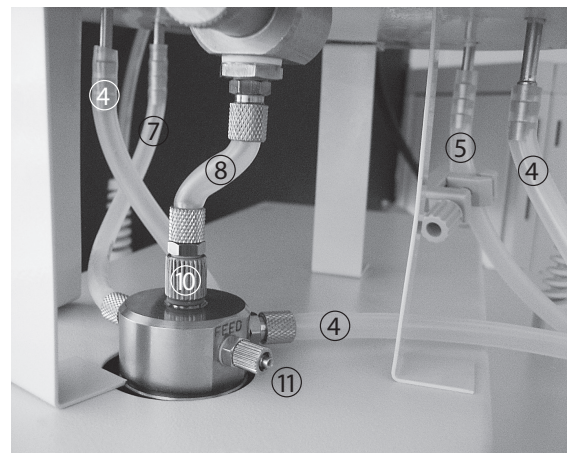
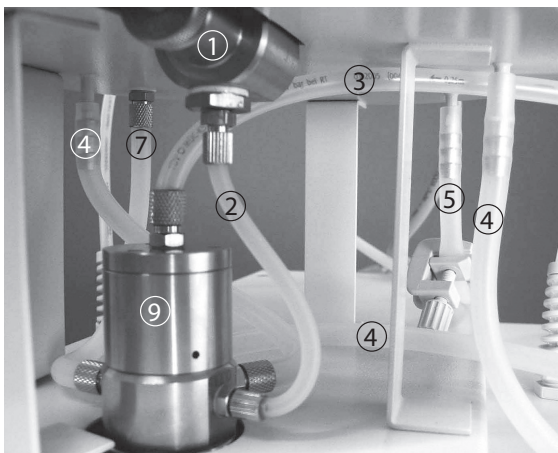

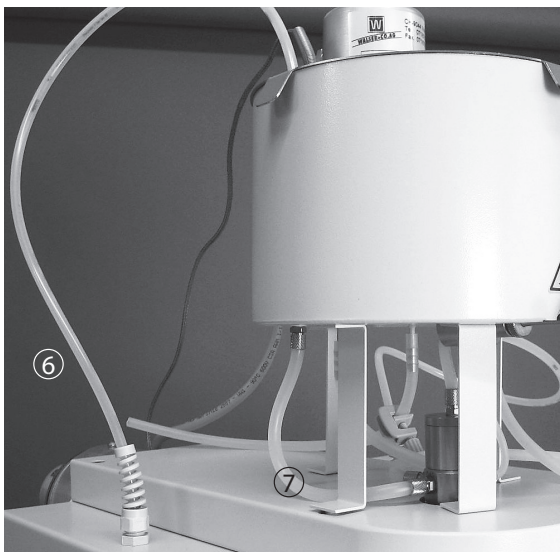
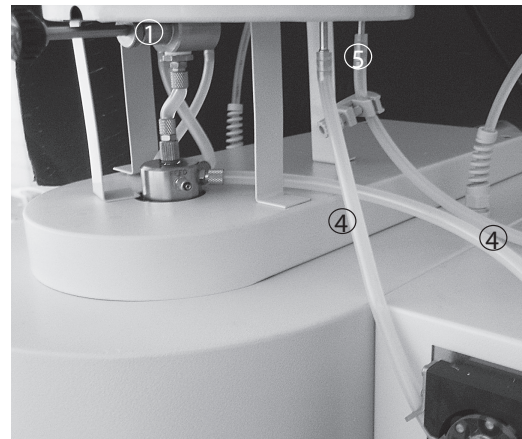
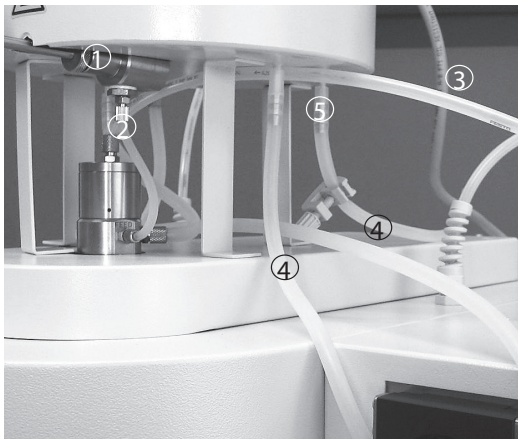

- Apply the tubes ② to ⑧ according to the above figures. For the tubes ④ and ⑤, apply cable binders to fixate them at their connection.
- Install the spray gas tube to the capillary inlet connector on top of the heating bath.
- Connect the gas flow tube from the capillary outlet to the nozzle inlet (gas).
- The feeding tube is connectable in two ways depending on whether the nozzle cleaning option is required or not.
- The heating liquid tubes are connected from the bath to the nozzle port (C in) and from the nozzle port (C out) through the pump back to the bath.
- This way, the nozzle is also heated to prevent any solidification and blocking.
- Adjust the peristaltic pump bed to the 6 mm silicone tube.

- ① Needle valve for dosage
- ② Feeding tube with nozzle cleaning option: Needle valve - nozzle (feed)
- ③ Cleaning gas nozzle: Instrument - nozzle (top)
- ④ Heating liquid tube: Bath - nozzle (C in) - nozzle (C out) - peristaltic pump - bath
- ⑤ Drain tube for heating liquid

- ⑥ Gas flow tube: Instrument - capillary inlet
- ⑦ Gas flow tube: Capillary outlet - nozzle (gas)
- ⑧ Feeding tube without nozzle cleaning option
- ⑨ Nozzle cleaning unit
- ⑩ Screw connection for feeding tube
- ⑪ Closed feed connection

Fig. 5.26: Installing the spray chilling tubing with (left) or without nozzle cleaning option (right)

## 5.15 Installation check

Carry out an installation check after a successful installation and prior to the first spray drying process.

- Inspect the glass visually for possible damage.
- Check the electrical connections.
- Make sure that the cover of the product collection vessel is connected to the instrument by means of the cable for arresting electrostatic charges.
- Make sure that the outlet temperature probe is inserted in the coupling.

## 6 Operation

This chapter gives examples of typical instrument applications and instructions on how to operate the instrument properly and safely.

	<p><b>! Danger</b></p> <p>Death or serious poisoning by inhalation or incorporation of dried particles during spray process.</p> <ul style="list-style-type: none"> <li>• Wear safety goggles</li> <li>• Wear safety gloves</li> <li>• Wear a suitable protective mask</li> <li>• Wear a laboratory coat</li> <li>• Check for proper sealing before use</li> <li>• Do not inhale dried particles</li> <li>• Stop drying gas flow before opening the drying circuit</li> </ul>
--	---

	<p><b>! Warning</b></p> <p>Death or serious poisoning by contact or incorporation of harmful substances at use.</p> <ul style="list-style-type: none"> <li>• Before operation, check the instrument for correct assembling</li> <li>• Before operation, inspect sealings and tubes for good condition</li> <li>• Exchange worn out or defective parts immediately</li> <li>• Exchange clogged filters immediately</li> <li>• Only operate the instrument in ventilated environments</li> <li>• Directly withdraw released gases and gaseous substances by sufficient ventilation</li> <li>• Perform a dry-run without sample material and check for gas leakages</li> </ul>
---	---

## 6.1 Layout of the operating and display elements



- ① Main switch
- ② Flow meter for spraying gas volume
- ③ Needle valve for gas flow adjustment

Fig. 6.1: Switch, flow meter and valve



- ① LED display current value inlet air temperature
- ② LED display current value outlet air temperature
- ③ LED display set value inlet air temperature
- ④ LED display aspirator output in % of max. aspirator rate
- ⑤ LED display pump output in % of max. pump rate
- ⑥ LED display for nozzle cleaning
- ⑦ Feed switch valve button
- ⑧ Nozzle cleaner interval adjustment
- ⑨ Manual operation pneumatic nozzle cleaner
- ⑩ Regulating push-button pump
- ⑪ Main switch pump
- ⑫ Regulating push-button aspirator
- ⑬ Main switch aspirator
- ⑭ Regulating push-button heating
- ⑮ Main switch heating

Fig. 6.2: Operating and display elements

## 6.2 Conversion tables for the parameters

### 6.2.1 Flow meter spraying air (rotameter)

The rotameter is an indicator for the spray gas flow. The table gives a correlation between indicated height and volume throughput. The nozzle has a certain pressure drop which increases with higher gas flow. As the gas volume strongly corresponds to the actual pressure, the table also contains a row for the effective volume flow, determined in a spray process with air.

Height (mm)	Liters/hour	Pressure drop (bar)	Actual volume flow (at standard temperature and pressure) in liters/hour
5	84		
10	138		
15	192		
20	246	0.15	283
25	301	0.18	355
30	357	0.23	439
35	414	0.3	538
40	473	0.41	667
45	536	0.55	831
50	601	0.75	1052
55	670	1.05	1374
60	742	1.35	1744
65	819	1.8	2293

### 6.2.2 Peristaltic pump

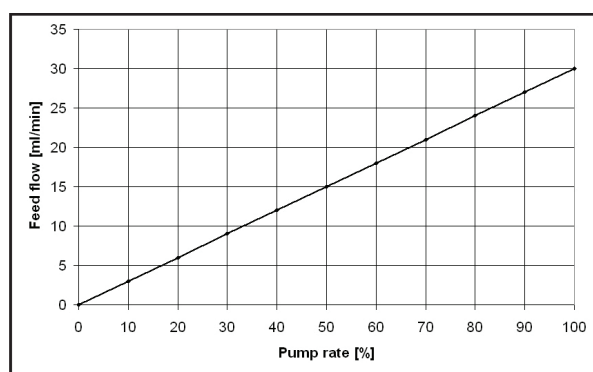

Fig. 6.3: Pump settings versus throughput

The peristaltic pump can be adjusted to different tubes according to the inner and outer diameters. With different tube diameters, the absolute flow is varying. The diagram shows the correlation for the standard silicone tube (2 mm ID, 4 mm OD) for water.

## 6.2.3 Aspirator

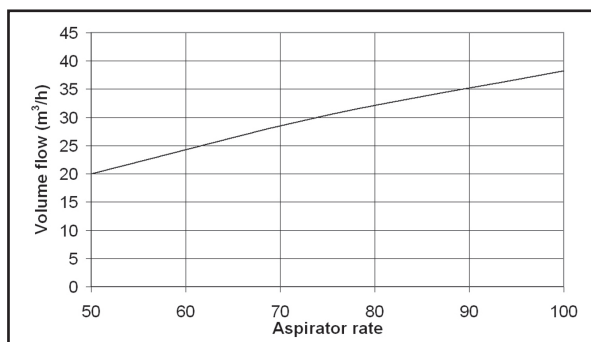



Fig. 6.4: Aspirator settings versus throughput

The aspirator has a maximum gas flow rate of approx. 35 m<sup>3</sup>/h. The flow depends on the pressure drop of the overall system.

To determine the exact volume flow for steady and reproducible operating conditions, a measurement tube is supplied as an accessory. A handheld gas flow meter (hot-wire flow meter) is required for the measurement.

## 6.3 Spray process

During the spray process some parts i.e. all glassparts can get hot according to the temperature settings of the instrument!

 	<b>Caution</b>
	<p>Risk of minor or moderate burnings when handling hot parts.</p> <ul style="list-style-type: none"> <li>• Do not touch hot parts</li> <li>• Let the system cool down for some minutes after use</li> </ul>

To carry out the spray process, proceed as follows:

1. Switch on the instrument. The instrument carries out an automatic self check and then switches automatically to the operating mode.
2. Set the air flow to about 40 mm with the rotary valve.
3. Pre-select the desired inlet temperature with the push-button.
4. Turn on the aspirator. As a standard, the aspirator rate should be 100 % to maximize the separation rate of the cyclone. If a small powder humidity is required, the aspirator rate can be decreased.
5. Turn on the heating and wait until the system has reached steady conditions.
6. If necessary, turn on the nozzle cooling.
7. Switch on the peristaltic pump. Pure solvent, e.g. distilled water in case of aqueous solutions, is now sprayed in. The spray cone is symmetrical and located in the axis of the spray cylinder. If this is not the case, the nozzle may be dirty or defective.
8. Set the automatic nozzle cleaning in case of clogging substance.
9. The spray quantity of pure solvent can be changed by means of the push-button of the peristaltic pump. The spray flow strongly influences the outlet temperature, since the water draws energy from the air by evaporation. Thus the outlet temperature can be set to the desired value by means of the quantity of sprayed solution via the pump speed of the peristaltic pump. The outlet temperature can be regarded as the upper thermal load of the product, so make sure that the product is not damaged as a result of an excessively high outlet temperature.
10. As soon as the desired operating conditions have been achieved and are stable, change the feed tube from pure solvent to the prepared feed solution.



## 6.4 Optimizing parameters

The parameters relevant for the spray process (aspirator and pump performance as well as inlet temperature) all correlate with and depend on each other. To give you an overview over the parameter settings best suited for your process, special training papers can be downloaded directly from the Internet.







Please visit our homepage [www.buchi.com](http://www.buchi.com). In the section Fields of Activities/Spray Drying, you will find the document to download.

## 6.5 End of spray process

- After the solution is completely spray dried, continue to spray pure solvent for a short time to remove product deposits from the hoses and the nozzle. Air and solvent should alternate to ensure an efficient cleaning.
- Pump the hoses empty, turn off the peristaltic pump and lower the pump bed.
- Turn off the nozzle cleaner.
- Turn off the heating. The system cools down now.
- As soon as the temperature in the instrument falls below 90 °C, you can turn off the aspirator.
- You can now remove the product collection vessel with the product.
- ATTENTION

Do not remove the product collection vessel when the aspirator is still on as the air stream might blow the product out of the vessel into the surrounding area.

## 6.6 Recovering particles of the outlet filter

      	<p><b>! Danger</b></p>
	<p>Death or serious poisoning by inhalation or incorporation of dried particles at recovery.</p> <ul style="list-style-type: none"> <li>• Wear safety goggles</li> <li>• Wear safety gloves</li> <li>• Wear a suitable protective mask</li> <li>• Wear a laboratory coat</li> <li>• Do not inhale dried particles</li> <li>• Stop drying gas flow before opening the drying circuit</li> <li>• Only recover particles in sufficiently ventilated flue or glove-box</li> <li>• Do not disperse the dried particles</li> <li>• Do not clean dusty parts with compressed air</li> </ul>

If the system is run with a PTFE filter, the fine particles can partially be recovered by counter-pulsating the filter membrane and blowing the particles away. For this purpose, proceed as follows:

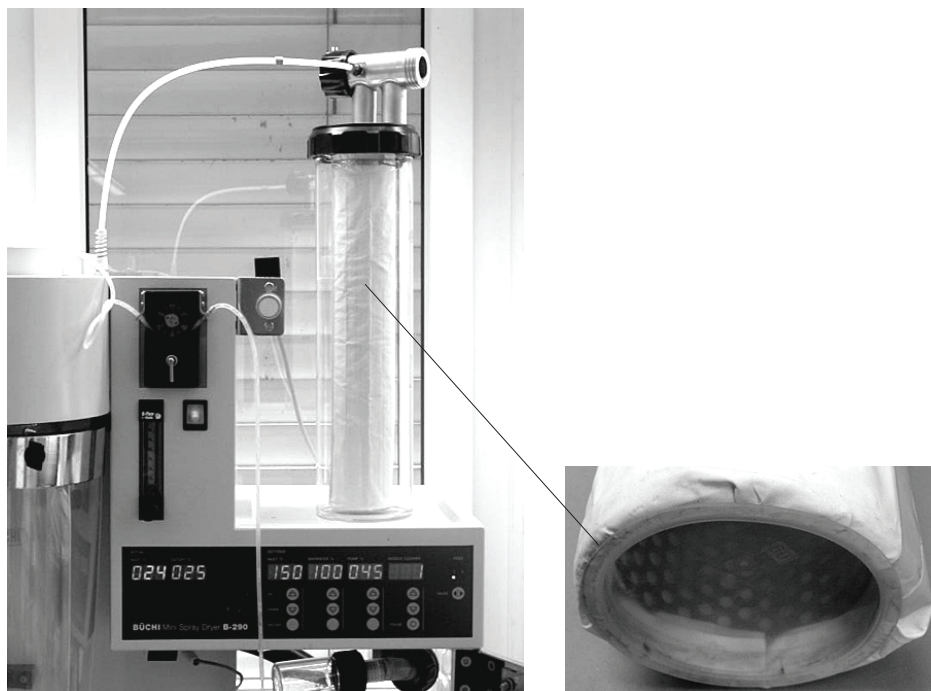



Fig. 6.5: Recovering particles of the outlet filter

- Attach the PTFE membrane instead of the polyester filter and close the bottom with a polypropylene plug.
- Separate the manometer tube from the filter and remove the filter housing completely from the holder.
- Put the filter on the product feed table. Disconnect the nozzle cleaning tube from the nozzle and connect it to the filter housing.
- Close the outlet gas connection with an SVL 42 screw cap.
- With the nozzle cleaning set on level 1, a pressure blow is generated every 5 seconds on the inner side of the filter leading to a separation of the fines from the membrane. The particles fall into the glass and can be recovered.



## 6.7 Operation with the Inert Loop B-295

	<p><b>! Danger</b></p> <p>Death or serious poisoning by gases or particles due to O<sub>2</sub>-sensor or filter malfunction</p> <ul style="list-style-type: none"> <li>• Exchange defective O<sub>2</sub>-sensor immediately</li> <li>• Exchange O<sub>2</sub>-sensor regularly within the specified maintenance intervals</li> <li>• Exchange clogged filters immediately</li> <li>• Exchange filters regularly within the specified maintenance intervals</li> <li>• Dispose of filter immediately</li> </ul>
	<p><b>! Danger</b></p> <p>Death by suffocation or serious poisoning by inhalation of inert gases.</p> <ul style="list-style-type: none"> <li>• Do not inhale inert gases</li> <li>• Directly withdraw released gases and gaseous substances by sufficient ventilation</li> <li>• Only operate the instrument in ventilated environments</li> <li>• Before operation, check all parts, connections and sealings involved in the gas flow for proper sealing</li> <li>• Exchange worn out or defective parts immediately</li> </ul>

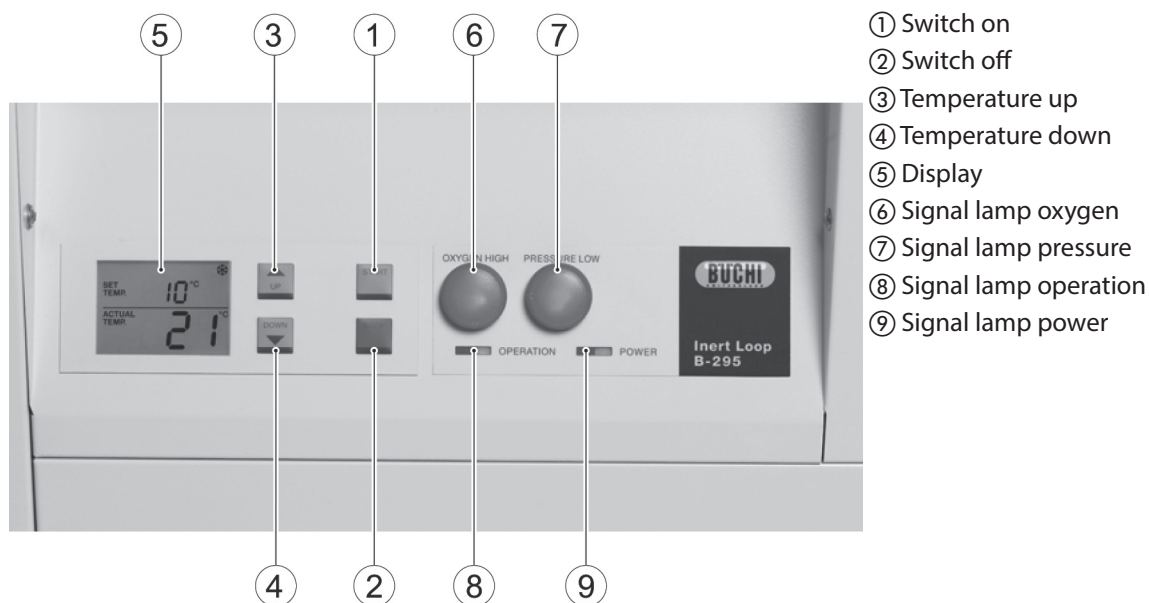

Fig. 6.6: Display of the Inert Loop B-295

To operate the instruments, proceed as follows:

1. Switch on the Mini Spray Dryer B-290 Advanced. The instrument automatically detects the connected periphery. Both signal lamps ⑥ and ⑦ at the Inert Loop B-295 are lit on. If the oxygen signal lamp ⑥ is off, there might still be enough inert gas in the loop. In this case, open one tube connection wherever possible and let the aspirator run for 2 minutes, as ambient oxygen concentration is required to check the oxygen sensor prior to each process. The Inert Loop B-295 starts immediately to cool down to the set temperature. If the instrument should not yet cool please press the button ①, if the instrument should be started again, press button ②.

Usually the Inert Loop is set on  $-20^{\circ}\text{C}$  for optimal solvent recovery. Some solvents tend to freeze in the Inert Loop B-295, while working with those please adjust the set temperature to a higher one, use the buttons ③ and ④. The display of the Inert Loop B-295 ⑤ shows the set temperature and the current temperature.

2. Switch on the aspirator (see figure 6.2 on page 52).
3. Check whether the spray gas source is an inert gas, normally nitrogen. Open the needle valve at the flow meter and adjust the flow to the requested level. The closed system now starts to be inertised (see figure 6.2 on page 52).
4. As soon as a certain pressure drop threshold is reached by the gas flow and spraying gas, the signal lamp of the pressure display ⑦ is switched off. If the pressure drops under the threshold (due to glass breakage, stop of gas inlet, taking away of a glass component etc.), the peristaltic pump and the heater are blocked. This is indicated by a lit signal lamp ⑦ and the message PR LO on the display of the Mini Spray Dryer B-290.
5. The overpressure in the system due to the constant flow inlet is limited by the exhaust outlet at the Inert Loop B-295, which is permanently open. Therefore, no overpressure can built up. The gas mixture from the exhaust outlet is slightly contaminated with solvents. This gas flow must undergo an after treatment and be disposed of according to regional standards and laws.
6. The oxygen concentration decreases due to the constant inlet of inert gas. As soon as the concentration is below 6 %, the signal lamp of the oxygen control ⑥ goes off. If the oxygen threshold of 6 % is exceeded (e.g. by using pressurized air instead of inert gas), the peristaltic pump and the heater are blocked. This is indicated by a lit signal lamp ⑥ and the message O2 HI on the display of the Mini Spray Dryer B-290.
7. As soon as both signal lamps ⑥ and ⑦ go off, the peristaltic pump and the heater are unblocked and can be turned on. The spray process can be started. The blocking and signals are reversible. If the pressure increases or the oxygen decreases, respectively, the pump and heater are unblocked again and must be started manually.
8. At the left bottom side of the Inert Loop B-295 a flask is positioned to receive the condensed solvent. To empty the flask, close the drain valve and take out the flask carefully.

### 6.7.1 Status messages

**Table 6-1: Status messages at the Mini Spray Dryer B-290**

Code	Description	Possible cause	Corrective measure
O2 HI	O <sub>2</sub> sensor indicates excessively high O <sub>2</sub> content	Oxygen connected instead of nitrogen	Connect nitrogen supply
		System not yet sufficiently inert (display on oxygen measurement equipment still above threshold level but falling)	Wait until threshold level is reached
		Oxygen enters system because of a leak	Check tubing system (seals in place and in proper condition, cover firmly closed)
PR LO	Pressure monitor shows operation taking place at too low pressure	Leakage in gas circulation system or clogged filter	Check tubing system (seals in place and in proper condition, cover firmly closed) or replace/clean filter

## 6.8 Operation with the Spray Chilling Accessory

To operate the Spray Chilling Accessory, proceed as follows:

1. Fill a heating liquid, e.g. water or a thermal oil (polyethylene glycol PEG 400 with low viscosity) into the heating bath and check whether the tubings are connected correctly. For sample melting points below 50 °C, water can be used as heating liquid. For melting points up to 70 °C thermal oil or polyethylene glycol is recommended. Consider the maximum heating liquid volume of 1.4 liters. Close product vessel with the PTFE cover and close the spray chilling accessory with the cover comprising the heating coil.
2. Switch on the Mini Spray Dryer B-290. The instrument is preset to the spray chilling mode, due to the connected long temperature probe.
3. Keep the feeding needle valve closed. Fill in the sample product into the product feed vessel.
4. Switch on the peristaltic pump with a pump rate of 60 % to circulate the heating liquid from the bath to the nozzle and back to the bath. Keep the heating liquid circulating.
5. Set the temperature of the heating bath. A heating temperature of about 50 % above the melting point of the product is recommended (e.g. melting point 60 °C: heating bath  $1.5 \times 60 \text{ °C} = 90 \text{ °C}$ ). Switch on the heater.
6. Turn on the compressed air flow to approximately 40 mm. The air is preheated through the hot capillary in the heating bath before entering the nozzle. Thus, the air will not lead to a cooling down of the melt in the nozzle.
7. Wait approximately 1 hour until the system is heated up and has reached steady state temperature conditions. The temperature is displayed as OUTLET temperature on the Mini Spray Dryer B-290.
8. Check if the melt in the product feed vessel is completely liquefied. Use a stirring stick to improve the melting process.
9. In case of an optional cooling of the inlet air, switch on the Dehumidifier B-296. The INLET temperature shows the temperature of the cooling air. Switch on the Dehumidifier B-296.
10. Switch on the aspirator. The aspirator generates the gas flow in the system. A setting of 100 % is recommended. Wait until the complete system has reached steady state conditions. Inlet air temperatures of around +10 °C to +15 °C can be reached with the Dehumidifier B-296. Check that the melt in the product feed vessel is completely liquid.
11. Open the needle valve carefully and watch the liquefied feed entering the feeding tube between needle valve and nozzle inlet. The hot melt will pour into the two fluid nozzle. In case of a blocked nozzle, push the nozzle cleaning. The spray chilling process starts.
12. Wait until the entire product is dispersed. A spray chilling run is typically quick and the particles are collected in the spray chamber and product collection vessel of the cyclone.
13. Switch off the aspirator, the heater, and the peristaltic pump and turn off the spray flow.
14. Remove the product collection vessel with the powder.
15. Carefully empty the heating liquid from the bath by opening the hose clamp of the drain tubing.
16. Let the spray chilling accessory cool down after the experiment with its covers on. Fill the spray chilling accessory with the cleaning agent and open the needle valve.
17. If the accessory is blocked remove it for cleaning. Use hot water, soap solutions and a brush. Put the blocked metal parts in a heating oven to melt the stocked product.
18. Wash all parts with water and let them dry.
19. The silicone tubing between the spray chilling accessory and the nozzle has to be replaced if it is blocked or broken.

## 6.9 Mini Spray Dryer B-290 acid resistant

For basic operations please see chapters 6.1–6.7.

Nozzle cleaning instructions

1. Clean the nozzle parts immediately after each spray drying run.
2. Wash the nozzle parts with a mild detergent solution.
3. Rinse the parts with hot water and let them dry.
4. Examine the nozzle parts under a microscope to verify that they are clean.
5. Check the integrity of the O-rings. Replace if necessary.



### NOTE



Do not use hydrochloric acid (HCl) for cleaning stainless steel.

Do not spray hydrochloric acid (HCl) because it will corrode the stainless steel parts.

## 7 Maintenance and repairs

This chapter gives instructions on all maintenance work to be performed in order to keep the instrument in good working condition.

	<p><b>! Danger</b></p> <p>Death or serious poisoning by inhalation or incorporation of dried particles during maintenance.</p> <ul style="list-style-type: none"> <li>• Wear safety goggles</li> <li>• Wear safety gloves</li> <li>• Wear a suitable protective mask</li> <li>• Wear a laboratory coat</li> <li>• Clean all parts thoroughly</li> <li>• Only maintain the instrument in ventilated environments</li> <li>• Do not inhale dried particles</li> <li>• Stop drying gas flow before opening the drying circuit</li> </ul>
	<p><b>! Warning</b></p> <p>Death or serious burning by electric current.</p> <ul style="list-style-type: none"> <li>• Switch off the instrument, disconnect the power cord and prevent unintentional restart before removing housing or parts of it</li> <li>• Do not touch parts inside the instrument with wet hands</li> <li>• Do not spill liquids over electronic components</li> <li>• Do not squeeze cables, tubes or other items at reassembling</li> <li>• Exchange defective cabling or tubing before reassembling</li> </ul>
	<p><b>! Warning</b></p> <p>Death or serious injuries by compressed air and gases.</p> <ul style="list-style-type: none"> <li>• Depressurize air and gas circuit first</li> <li>• Wear safety goggles</li> </ul>

 	<p><b>CAUTION</b></p> <p>Minor or moderate injuries by hot heating bath content.</p> <ul style="list-style-type: none"> <li>• Do not drop any water into the hot heating liquid</li> <li>• Wear safety goggles</li> </ul>
	<p><b>Notice</b></p> <p>Risk of instrument and instrument damage by liquids and detergents.</p> <ul style="list-style-type: none"> <li>• Do not spill liquids over the instrument or parts of it</li> <li>• Wipe off any liquids instantly</li> <li>• Use ethanol or soapy water as detergent only</li> </ul>

### 7.1 Housing

Check the housing for defects (switches, plugs) and clean it regularly with a damp cloth.

### 7.2 Glass assembly, tubes

Clean the glass assemblies after each spray process. The glass assemblies can be taken out and cleaned with commercially available cleaning agents or in an ultrasonic bath. After the glass parts have been cleaned and fully dried, check each part visually for cracks, scratches and for any parts or sections that might have splintered off. Take out and replace any damaged glass parts. Clean the tubes after each spray process with commercially available cleaning agent.

### 7.3 Nozzles

A special brush is supplied to clean the central tube of the nozzle body. Most efficient cleaning of all nozzle types is done in an ultrasonic bath. Clean the tubes and nozzles after each spray process. The tubes and nozzles can be cleaned with commercially available cleaning agents.

## 7.4 Aspirator cleaning

The aspirator of the Mini Spray Dryers can be contaminated from particles, especially when no outlet filter is used. This is a description how to clean the aspirator efficiently and fast.



Disconnect the "Polypress" tube from the glass assembly and heater respectively.

Fig. 7.1: Disconnecting Polypress tube

- Fill one vessel with water and prepare an empty canister with a small opening.
- Insert the exhaust tube from the aspirator into one third of the empty canister and fix the tube.
- Set the aspirator to 50 % and switch it on. Carefully move the inlet tube over the surface of the water to suck in a mixture of air and water.
- Do not immerse the tube into the water. Be aware that no splashes are contaminating the ambient at the outlet side.
- Increase the aspirator rate up to 80 %, continue to draw water through the aspirator. Be careful, that the exhaust tube in the receiving tank remains in the air to prevent splashes.
- Continue this procedure unless clean water is coming out of the aspirator.
- Let the aspirator run for approximately 1 hour to dry residual water in the aspirator away.

## 7.5 Inert Loop B-295 and Dehumidifier B-296

The sealed working circuits of the devices and the optional heat exchanger in combination with the Inert Loop B-295 and Dehumidifier B-296 can be flooded completely for cleaning purpose.

	<b>Notice</b>
	<p>Risk of instrument and instrument damage by liquids and detergents.</p> <ul style="list-style-type: none"> <li>• Do not spill liquids over the instrument or parts of it</li> <li>• Wipe off any liquids instantly</li> <li>• Use ethanol or soapy water as detergent only</li> </ul>

- Switch off all relevant devices and unplug the respective power cords.
- Remove the molecular sieve bag for the duration of cleaning if installed.
- Check all sealings and tubes for good condition and proper sealing.
- Raise the exhaust tube and fill the system through the inlet with cleaning medium (e.g. ethanol).

- Provide a collection vessel to collect the cleaning medium flowing from the system. Open the drain valve and lower the exhaust tube, so that the cleaning medium flows out.
- Rinse out and dry the condensate vessel.
- Reinstall the condensate vessel.
- To dry the working circuit connect the Mini Spray Dryer B-290 and dry it by running the Aspirator with dry air.

## 7.6 Outlet filter

If the pressure drop of the outlet filter increases by more than 20 mbar relative to the clean filter, take the filter out and wash it manually or in a laboratory washing machine or replace it by a new filter.

	<b>Notice</b>
	<p>Risk of instrument damage by internal overpressure.</p> <ul style="list-style-type: none"> <li>• External supply pressure must meet the system specifications</li> <li>• Exchange clogged filters immediately</li> <li>• Safely dispose filter immediately</li> </ul>

## 7.7 Calibrating the oxygen sensor of the Inert Loop B-295

The oxygen sensor is already calibrated ex works. However, due to shipping and other influences, the sensor might have to be calibrated again. At atmospheric condition, it has to display  $21.0 \pm 1.5\%$ .

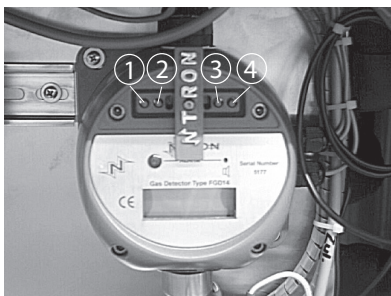

Fig. 7.2: Calibrating the oxygen sensor

- Remove the small front plate with a screwdriver
- Remove the small front panel on the upper right side with a screwdriver.
- Press menu ④, C:01 will appear.
- Press UP ② DOWN ① to change to C:02.
- Press Enter ③, the oxygen concentration is shown on the display.
- Press Enter ③ again to calibrate the sensor.
- Press Menu ④ to quit the menu mode.



## 7.8 Replacing the oxygen sensor of the Inert Loop B-295

After approximately 2 years of operation the oxygen concentration displayed by the sensor decreases drastically.



Fig. 7.3: Replacing the oxygen sensor

The sensor should now be replaced. For this purpose:

- Open the front plate with an allen key.
- Disconnect the cable by turning the plug.
- Screw the sensor out and replace it by a new one.
- Reconnect the cable.
- Calibrate the sensor according to chapter 7.6, Calibrating the oxygen sensor.

## 7.9 Spray chilling accessory

Prior to cleaning, let the spray chilling accessory cool down with its covers on.

For cleaning, proceed as follows:

- Fill the spray chilling accessory with the cleaning agent and open the needle valve.
- If the accessory is blocked remove it.
- Use hot water, soap solutions and a brush for cleaning.
- Put the blocked metal parts in a heating oven to melt the stocked product.
- Wash all parts with water and let them dry.
- The silicone tubing between the spray chilling accessory and the nozzle has to be replaced if it is blocked or broken.

## 7.10 Customer service

Only authorised service personnel are allowed to perform repair work on the instrument. These persons have a comprehensive technical training and knowledge of possible dangers which might arise from the instrument.

Addresses of official BUCHI customer service offices are given on the BUCHI website under: [www.buchi.com](http://www.buchi.com). If malfunctions occur on your instrument or you have technical questions or application problems, contact one of these offices.

The customer service offers the following:

- Spare part delivery
- Repairs
- Technical advice

## 8 Troubleshooting

This chapter helps to resume operation after a minor problem has occurred with the instrument. It lists possible occurrences, their probable cause and suggests how to remedy the problem.

The troubleshooting table below lists possible malfunctions and errors of the instrument. The operator is enabled to correct some of those problems or errors by him/herself. For this, appropriate corrective measures are listed in the column "Corrective measure".

The elimination of more complicated malfunctions or errors is usually performed by a BUCHI technical engineer who has access to the official service manuals. In this case, please refer to your local BUCHI customer service agent.

### 8.1 Error messages and their remedy

**Table 8-1: Error messages and their remedy**

Code	Description	Possible cause	Corrective measure
001	Entry temperature sensor interruption	Defective sensor, sensor cable or internal wiring	Contact the BUCHI customer service
002	Entry temperature sensor short-circuit	Defective sensor, sensor cable or internal wiring	Contact the BUCHI customer service
003	Entry temperature excessively high (> 230 °C)	Defective heating control or heating relay	Contact the BUCHI customer service
004	Exit temperature sensor interruption	Defective sensor, sensor cable or internal wiring	Contact the BUCHI customer service
005	Exit temperature sensor short-circuit	Defective sensor, sensor cable or internal wiring	Contact the BUCHI customer service
006	Exit temperature excessively high	Defective sensor, sensor cable or internal wiring	Contact the BUCHI customer service
010	Malfunction of frequency converter	Defective frequency converter or wiring	Contact the BUCHI customer service
011	Heating malfunction	See "System does not heat up"	See "System does not heat up"
Only for operation with the Remote Control Panel			
100	Connection to Remote Control Panel interrupted or disconnected	Defective connection cable or instrument is not plugged in	Check connection cable for damage and insert plug, if necessary
Only for operation with the Inert Loop B-295			
200	Connection to B-295 interrupted or disconnected	Defective connection cable or instrument is not plugged in	Check connection cable for damage and insert plug, if necessary
201	B-295 plugged in while operation in process	Connection cable plugged in after switching on instrument	Restart the system
202	O <sub>2</sub> alarm not given during start-up	Oxygen sensor "spent" Oxygen measuring equipment defective	Replace the oxygen sensor Contact the BUCHI customer service

**Table 8-1: Error messages and their remedy (cont.)**

Code	Description	Possible cause	Corrective measure
203	Pressure alarm not given during start-up	Pressure switch defective or contaminated	Contact the BUCHI customer service
204	Humidity sensor above threshold	Molecular sieve saturated with water	Exchange the molecular sieve bag and regenerate the used one

## 8.2 Malfunctions and their remedy

**Table 8-2: Malfunctions and their remedy**







Malfunction	Possible cause	Corrective measure
Equipment cannot be switched on	No voltage	Insert mains plug/examine plug for damage
	Fuse has blown	Replace the fuse (3.15 A)
Peristaltic pump does not deliver	The rollers are not in contact with the running surface	Elevate the running surface with the lever Adjust the lifting height of the running surface with the hexagonal allen key from beneath
Product is delivered after the spray flow is switched on although the pump is switched off	The pressure of the rollers on the running surface is too weak	Adjust the lifting height of the running surface with the hexagonal allen key from beneath
Aspirator is noisy	The aspirator is dirty	Clean the aspirator If no discharge filter is fitted, this should be done to avoid further contamination of the aspirator
	The operating mode is set to "Blow"	Reset to "Suction" mode if possible
System does not heat up	Heating circuit not plugged in	Plug in heating circuit
	Heating is not switched on	Switch on heating circuit
	Nominal entry temperature is below room temperature	Pre-select a new inlet temperature
	Fuse has blown	Replace fuse (12.5 A)
	Heater defective	Contact the BUCHI customer service
Nozzle blocked up	Faulty tubing system (Faulty flow direction or no flow in the heating system)	Check tubing system
	Product is too concentrated	Use a lower concentration in pump Increase number of pulses for nozzle cleaning
	Encrustation on nozzle exit Nozzle is not clean	Cool nozzle with cooling water Completely dismantle the nozzle (nozzle cap, tip, cleaning needle) and clean with water
	Nozzle is defective (bent nozzle needle)	Replace nozzle or defective element

**Table 8-2: Malfunctions and their remedy (cont.)**

Malfunction	Possible cause	Corrective measure
Product drips in spray chamber	No spray flow	Open compressed air valve
	Insufficient spray flow	Inspect pressure of air in the supply tube (5–8 bar)
Insufficient aspirator performance	Discharge filter blocked	Dismantle filter and clean it
Deposits on the spray cylinder	Nozzle is not clean	Completely dismantle the nozzle and clean with water
	Nozzle is defective (bent nozzle needle)	Replace nozzle or defective element
	Product will not dry	Reduce the temperature difference between entry and exit Increase rate of gas spray flow (> 600 l/h) Reduce peristaltic pump performance
	Entry temperature is above the melting point of the product	Reduce entry temperature
	Product related deposits	No action possible
	Wide spray angle deposits droplet on the spray cylinder wall	Narrow the spray angle by adjusting the spray cap position
Glass elements become wet	Peristaltic pump lever has become loose	Tighten lever
Irregular or pulsed spraying	Leaks in the spray nozzle	Check seals in the spray nozzle and replace if necessary
Deposits in the cyclone	Product related deposits	No measure possible
	Static charge build-up	Insert earthing cable
	Product too moist	Increase exit temperature to dry the product
	Temperature too high	Reduce aspirator performance to reduce residence time of product
Exit temperature does not rise	Sensor not inserted	Place probe in coupling element
	Fault in tubing system	Check tubing system
Entry temperature falls	Heating is switched off	Switch on heating
	Heater plug is unplugged	Insert heater plug
	Fuse has blown	Replace fuse (12.5 A)
Exit temperature falls	No heating	Follow measures under "Fall of entry temperature"
	Spraying too powerful	Reduce production rate of peristaltic pump
Exit temperature rises	Nozzle blocked	Clean the nozzle by actuating the cleaning button or by switching on cleaning nozzle Increase number of pulses for the nozzle cleaning activity
	Hose not dipped into stock solution	Dip hose into product
	Change of concentration in stock solution	Agitate product (magnetic agitator) to obtain uniform concentration
	No feed of product	Switch on peristaltic pump

## 9 Shutdown, storage, transport and disposal

This chapter instructs how to shut down the instrument, how to pack it for storage or transport, and specifies the storage and shipping conditions.

     	<b>! WARNING</b>
	<p>Death or serious poisoning by contact or incorporation of harmful substances.</p> <ul style="list-style-type: none"> <li>• Wear safety goggles</li> <li>• Wear safety gloves</li> <li>• Wear a laboratory coat</li> <li>• Clean the instrument and all accessories thoroughly to remove possibly dangerous substances</li> <li>• Do not clean dusty parts with compressed air</li> <li>• Store the instrument and its accessories at a dry place in its original packaging</li> </ul>

### 9.1 Storage and transport

Switch off the instrument and remove the power cord. Clean the instrument thoroughly! Remove all liquids and dusty residues before packaging the instrument.

#### NOTE

When returning the instrument to the manufacturer for repair work, please copy and complete the health and safety clearance form (section 11) and enclose it with the instrument.

### 9.2 Disposal

To dispose of the instrument in an environmentally friendly manner, a list of materials is given in chapter 3. This helps to ensure that the components are separated and recycled correctly. Please follow valid regional and local laws concerning disposal.

You have to follow valid regional and local laws concerning disposal.

#### NOTE

For help, please contact your local authorities!

## 10 Spare parts

This section lists spare parts, accessories and options including their ordering information. Only order spare parts and consumables from BUCHI to maintain the warranty status and to assure best performance and reliability of the system and affected components. Any modifications to the spare parts used are only allowed with the prior written permission of the manufacturer.

Always state the product designation, instrument serial and part numbers for warranty clearance when ordering spare parts!

### 10.1 Spray nozzle

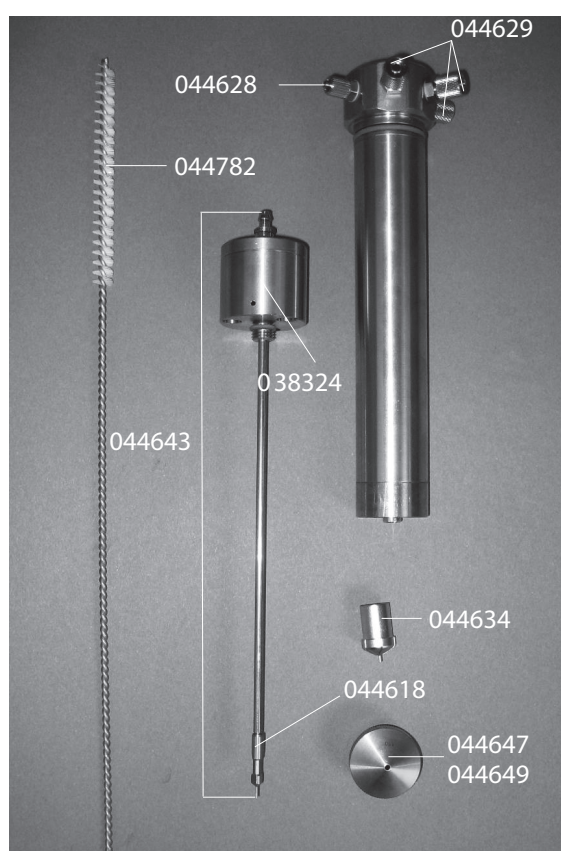

**Table 10-1: Spray nozzle**

Description	Ordernumber
Needle for nozzle cleaning	044618
Screw connection product tube	044628
Screw connection air and cooling	044629
Nozzle tip (0.7 mm)	044634
Nozzle cleaning (0.7 mm), complete	044643
Nozzle cap (1.5 mm)	044647
Nozzle cap (1.4 mm )	044649
Set of O-rings	044759
Metallic spring	038324
Cleaning brush for nozzle	044782

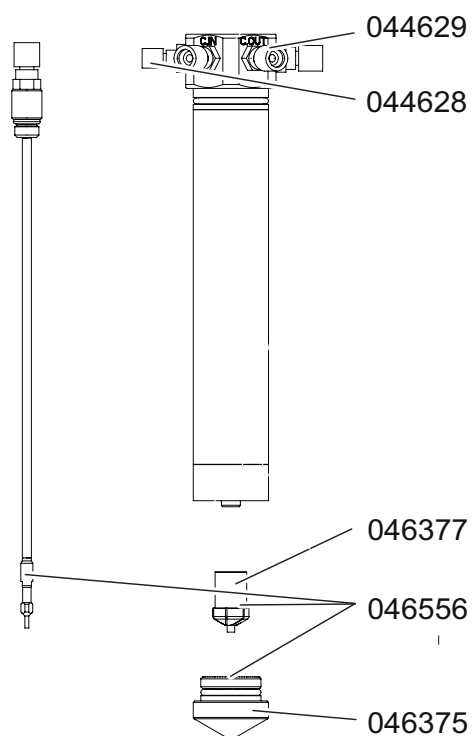
**Table 10-2: Three fluid nozzle**

Description	Ordernumber
Three fluid nozzle, complete	046555
Three fluid nozzle conversion kit	046556
Screw connection product tube	044628
Screw connection air and cooling	044629
Nozzle tip (2.0 mm)	046377
Nozzle cap (2.8 mm)	046375
Set of O-rings	044759

**Table 10-3: Spray Nozzle Ø 1.4 mm**

Description	Ordernumber
Nozzle exchange set, complete	046380
Nozzle Tip (1.4 mm)	046376
Needle (1.4 mm)	046372
Nozzle Cap (2.2 mm)	046374

**Table 10-4: Spray Nozzle Ø 2.0 mm**





Description	Ordernumber
Nozzle exchange set, complete	046381
Nozzle Tip (2.0 mm)	046377
Needle (2.0 mm)	046373
Nozzle Cap (2.8 mm)	046375

**Table 10-5: Spray Nozzle Ø 0.5 mm**

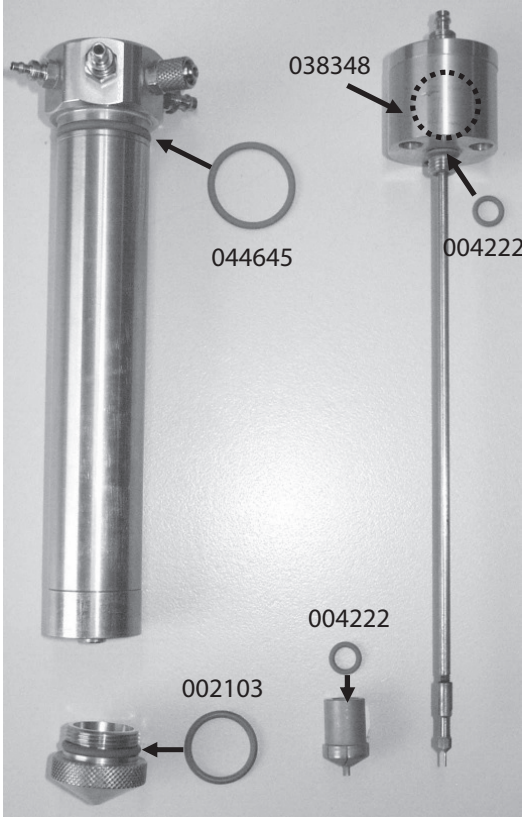
Description	Ordernumber
Nozzle Tip (0.5 mm)	11056865
Needle (0.5 mm)	11056864
Nozzle Cap (1.4 mm)	044649

**Table 10-6: Standard O-rings FKM, for all standard to medium-aggressive applications**





	Description	Ordernumber
 21.0x2.0 mm	O-ring for nozzle, FKM (green), 2x	044645
 16.0x2.0 mm	O-ring nozzle capsilicone (red), 2x	002103
 6.0x1.5 mm	O-ring for needle and nozzle tip, FKM (green), 4x	004222
 3.0x1.5 mm	O-ring for nozzle cleaner, FKM (black), 2x	038348
Set, complete	<b>Set of standard O-rings, complete</b>	<b>044759</b>

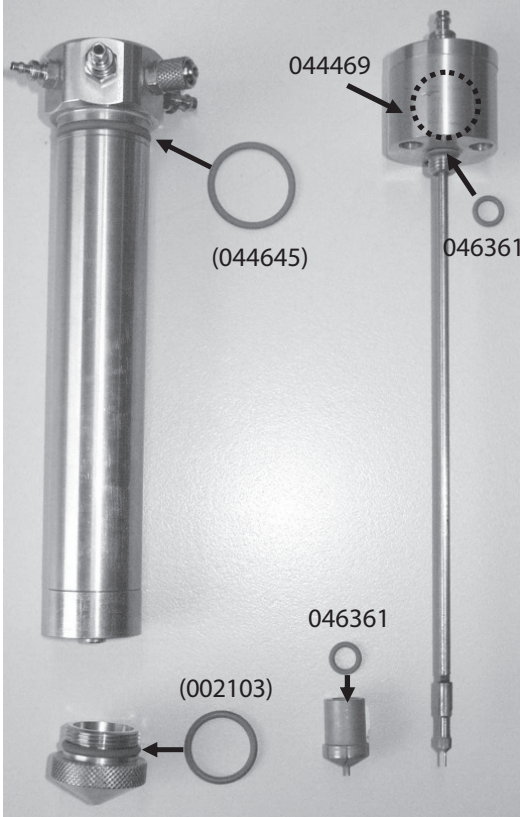

**Table 10-7: Highly resistant O-rings FFKM, for all medium to aggressive applications**



Description	Ordernumber
 O-ringforscrewcoupling, FFKM (black), 2x 37.69x3.5 mm	046363
 O-ring for nozzle tip, FFKM (green), 2x 6.0x1.5 mm	046361
 O-ringfor nozzle cleaner, FFKM (black), 2x 3.0x1.5 mm	044469
<b>Set of FFKM O-rings, complete</b> Set, complete	<b>046364</b>

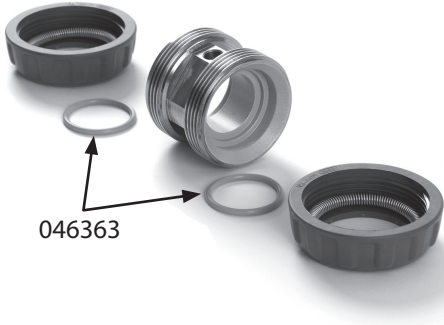

NOTE  
 O-rings in brackets are part of the standard O-ring set, order no. 044759!

## 10.2 Glass parts

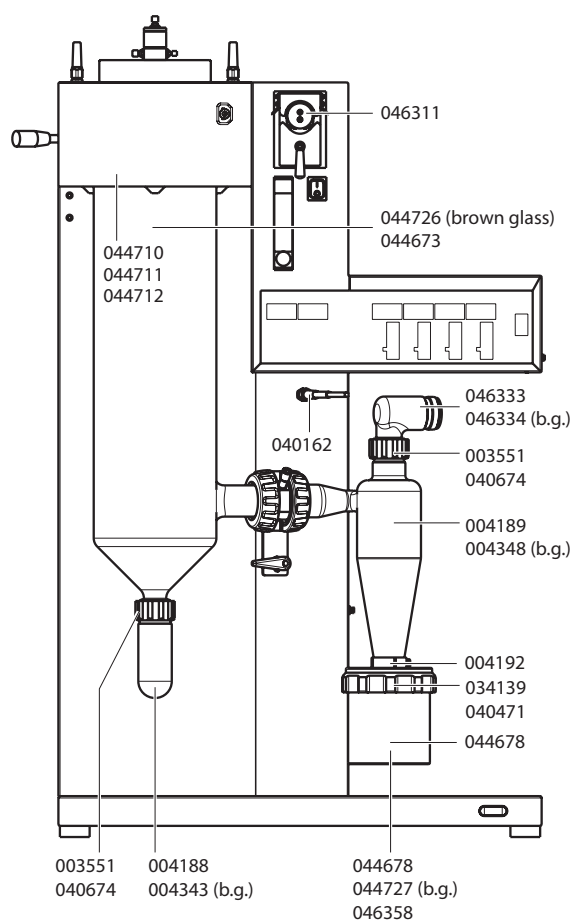
**Table 10-8: Glass parts 1**

Description	Ordernumber
Glass assembly, complete	044680
Glass assembly with high performance cyclone, complete	11056987
Screw cap SVL 42	003551
Separation flask	004188
Standard cyclone	004189
Large collection vessel for standard cyclone 1.1 l	11056990
Standard cyclone complete with collection vessel	042884
Seal to cyclone	004192
Flange screw coupling	034139
Outlet temperature sensor	040162
Seal to product collection vessel	040471
Silicone seal SVL 42	040674
Angle piece	046333
Cylinder, sideways outlet	044673
Product collection vessel	044678
Holder to spray cylinder	044710
O-ring to spray cylinder	044711
Screw to holder	044712
Cover to product collection vessel	046318
Resistant O-ring set in FFKM	046364
Plastic closure for product collection vessel	046358
Set of peristaltic rolls	046311

**Table 10-9: Glass parts in brown glass (protection for light sensitive substances)**

Description	Ordernumber
Glass assembly, complete	044758
Spray cylinder, sideways outlet	044726
Spray cylinder, vertical outlet	044728
Separation flask	004343
Angle piece	046334
Standard cyclone	004348
Product collection vessel	044727

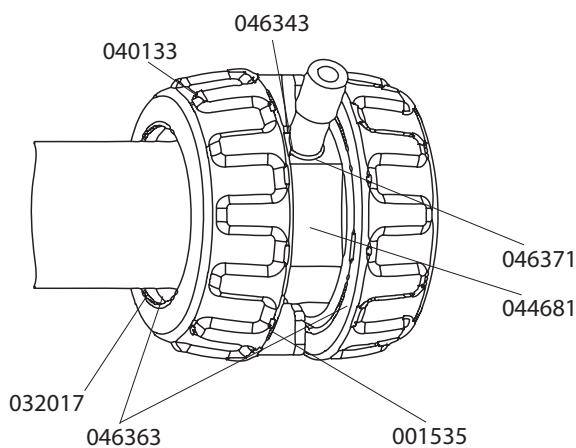
**Table 10-10: Glass parts 2**

Description	Order number
O-ring FKM for screw coupling	001535
Tension spring	032017
Set flange screw coupling (2 units)	040133
Set O-ring and clamping ring (5 units)	046343
O-ring FFKM for screw coupling	046363
Coupling flange	044681
O-ring for temperature sensor 5.0x2.5 FFKM	046371

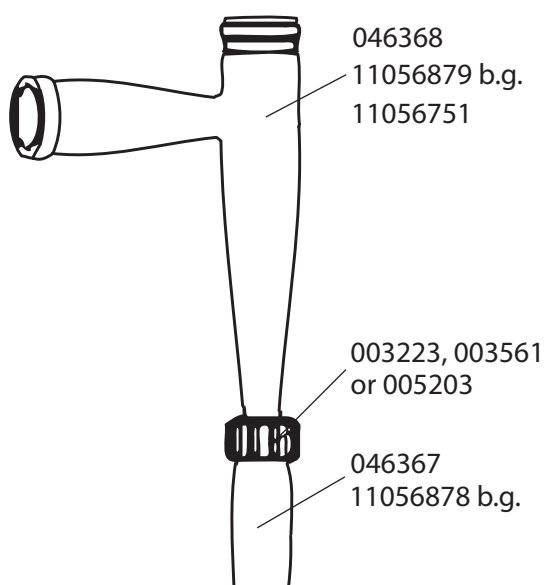
**Table 10-11: High-performance cyclone**

Description	Order number
High-performance cyclone	046368
Small product collection vessel	046367
Screw ring SVL 30	003223
PTFE seal SVL 30x20	005203
Silicone seal 30x20	003561
High-performance cyclone complete (all above numbers)	046369
High-performance cyclone not coated	11056751

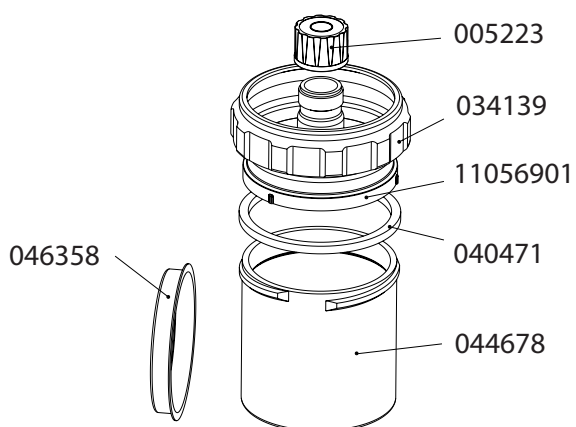
**Table 10-12: Large product collection vessel for high-performance cyclone**

Description	Order number
Screw cap SVL 30	005223
Flange screw coupling	034139
Coupling glass flange SVL 30	11056901
Sealing	040471
Product collection vessel	044678
Plastic closure	046358
Large product collection vessel complete (all above numbers)	11056899

**Table 10-13: High-performance cyclone in brown glass (protection for light sensitive substances)**

Description	Order number
High-performance cyclone, brown glass	11056879
Small product collection vessel, brown glass	11056878

## 10.3 Filters

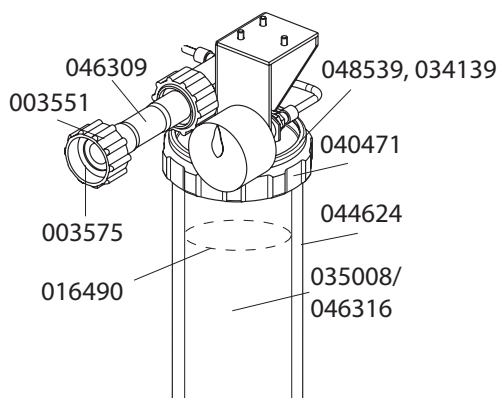
**Table 10-14: Outlet filter**

Description	Ordernumber
Outlet filter, complete	044754
Screw cap SVL 42	003551
PTFE Seal SVL 42	003575
FlangescrewcouplingPOMcopolymer	034139
Aluminum flange screw coupling for outlet temperatures higher than 80°C	048539
Seal to product collection vessel	040471
Polyester filter bags (6 units)	035004
Polyester filter bag (1 unit)	035008
Filter glass	044624
Filter tube, complete	046309
PTFE membrane filter	046316
Hose clamp 60 - 80 mm	016490

**Table 10-15: Inlet filter**

Description	Ordernumber
Inlet filter, complete	011235
Replacement filter with seal	011238

## 10.4 Tubings and connectors

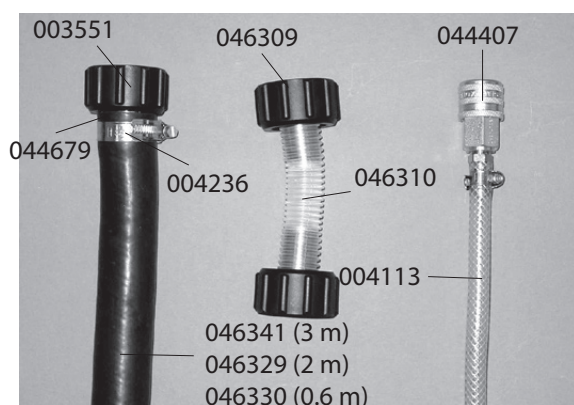
**Table 10-16: Tubing**

Description	Ordernumber
Solaflex tube 8.0/13.5 mm (5 m)	004113
Silicone tube (per m)	004138
Silicone tube for nozzle cooling (4 m)	004139
ICO quick coupling	044407
Polypress tube (3 m)	046341
Polypress tube (2 m)	046329
Polypress tube (0.6 m)	046330
Filter tube, complete	046309
0.1 m flextube PFA	046310

**Table 10-16: Tubing (cont.)**

Description	Ordernumber
Tygon tube MH2375 transparent (perm)	046314
Tygon tube F 4040 A yellow (per m)	046315
Screw cap SVL 42	003551
Connecting piece for polypress tube	044679
Hose clamp 25–40 mm	004236
Quick hose coupling	045656
Sealing FKM for hose coupling	11056479

## 10.5 Trolley

The trolley consists of powder-coated stainless steel.  
Dimensions (L×W×H): 850×420×560 mm

**Table 10-17: Trolley**

Description	Ordernumber
Trolley	041257

## 10.6 Measurement pipe for gas flow

For the precise determination of the gas flow in absolute measures. A pipe generates a laminar flow for the determination with a hot-wire instrument. The appropriate instrument can be supplied by Testo ([www.testo.com](http://www.testo.com)) type Test 435 with sensor No. 0635 1044.

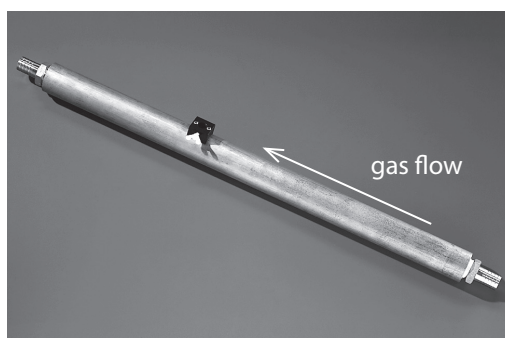
**Table 10-18: Measurement tube**

Description	Ordernumber
Measurement pipe for gas flow	044790

## 10.7 Feed switch valve

For safe and automated switching between pure solvent and product when starting and ending the spray drying process.

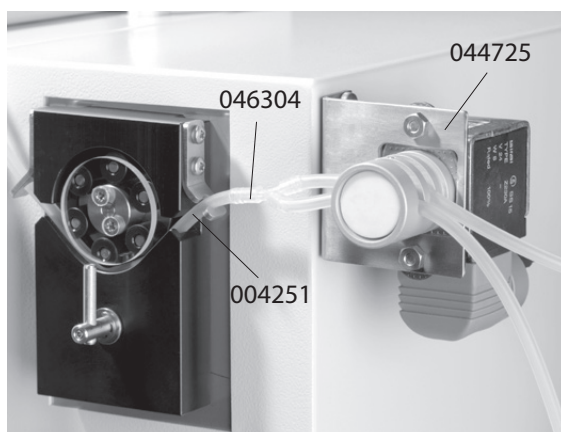

**Table 10-19: Feed switch valve**

Description	Ordernumber
Feed switch valve	044725
Y-piece connector	046304
Metal tube connector	004251

## 10.8 Remote control panel



**Table 10-20: Remote control panel**

Description	Ordernumber
Remote control panel	044702

## 10.9 Inert Loop B-295



**Table 10-21: Inert Loop and Dehumidifier**

Description	Ordernumber
Receiving vessel for solvent	040398
PTFE tube to receiving vessel	004105
PTFE hose connection SVL 22	027338
Oxygen sensor	046348
Extension communication cable B-290/B-295 (3 m)	11056989



**Table 10-22: Dehumidifier B-296**

Description	Ordernumber
Woulff bottle	041875
Screw cap SVL 22	003577
Closed screw cap SVL 22	005222
Gasket 22x17 PTFE	005155
PTFE hose connection SVL 22	027338
Polypress tube (2 m)	046329
Hose clamp 25–40 mm	004236

## 10.10 Cylinder insulation

With the cylinder insulation the process is carried out with less product loss, closer to scale-up conditions, and more energy-efficient.

**Table 10-23: Cylinder insulation**

Description	Ordernumber
Cylinder insulation	040058

## 10.11 Spray chilling accessory

**Table 10-24: Spray Chilling accessories**

Description	Order number	Description	Order number
Screw connection 6/4	044629	Sealing D20, 10.5×2	010804
Silicone tubing D6/9	004133	PE tubing D4/6	004386
SiliconetubingD4/7(pumptube)	004139	L-type connector D6	045519
Screw connection M5/M8	046557	Conversion kit for Spray Chilling accessory (necessary for Mini Spray Dryer B-290 instruments older than 2005)	040060
O-ring FKM 70, 6.0×1.5	004222	Cleaning brush	044782
Hose clip	042655	FEP tubing D4/6	043366
Temperature sensor	040163		

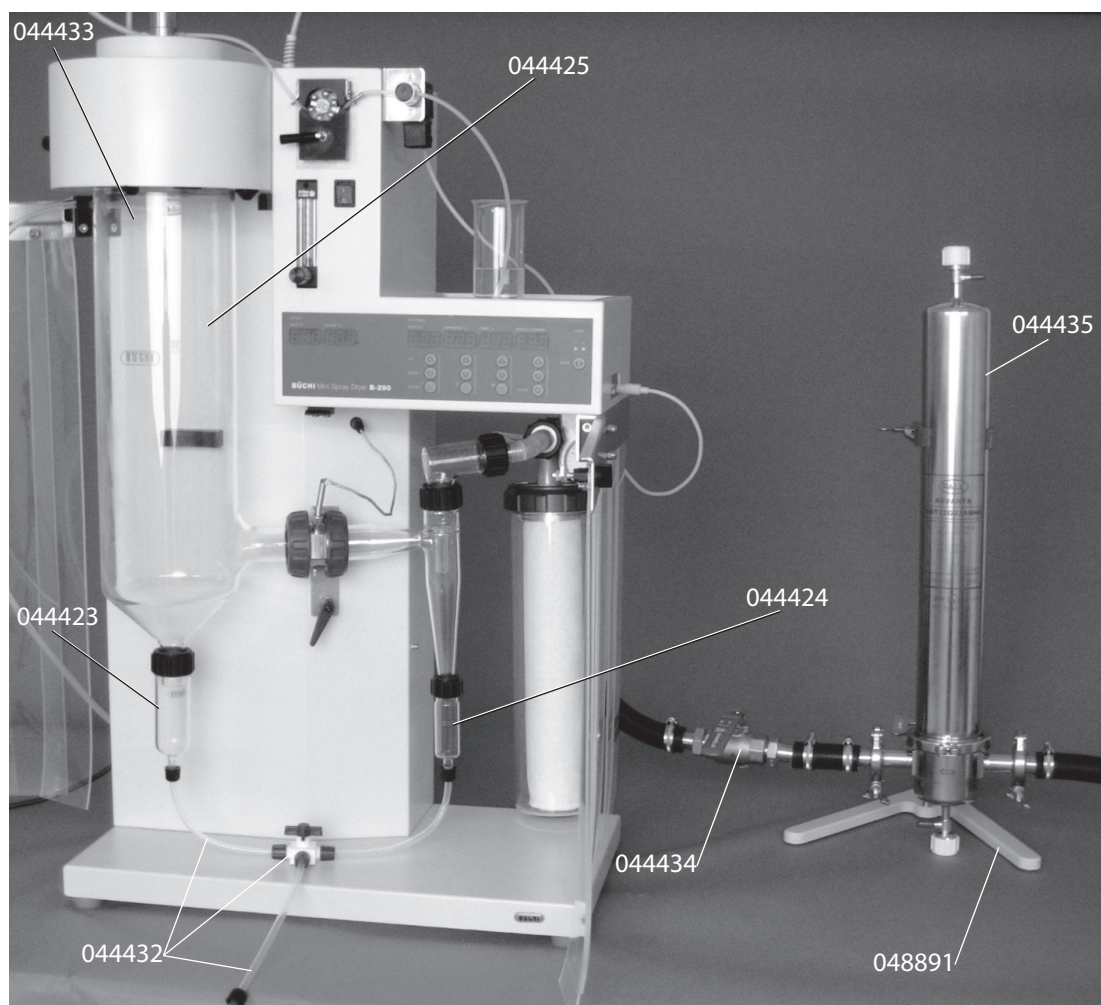

## 10.12 Pre-cleaning glass-set and sterile filter

**Table 10-25: Pre-cleaning glass-set and sterile filter**

Description	Order number	Description	Order number
Separator pre-cleaning glass	044423	Spray cylinder pre-cleaning glass	044425
Small separator pre-cleaning glass	044424	Drain tubing for pre-cleaning glass	044432
Sterile Filter for pre-cleaning glass	044435	Feed tubing for pre-cleaning glass	044433
Pre-cleaning glass set	044441	Ball valve 1" complete	044434
Support rod for sterile filter	048891		

## 10.13 Acid resistant accessories

**Table 10-26: Acid resistant accessories**

Description	Ordernumber	Description	Ordernumber
① Nozzle set 1.4 mm titanium cpl.	11056415	⑥ Glass assembly acid resistant complete	11056386
Nozzle set 2.0 mm titanium cpl.	11056416	⑦ Spray cylinder holder PFA coated	11056324
② Outlet filter acid resistant cpl.	11056333	Knurled screws PFA coated	11056325
③ Cyclone metall cover PFA coated	11056327	⑧ Two-fluid nozzle acid resistant	11056320
④ Sensor support adapter	11056318	Three-fluid nozzle acid resist.	11056971
Clamp ring ID 8 mm	11056387	⑨ Filter body PFA coated	11056335
O-ring of fluoroelastomer 7×1.5 mm	004223	⑩ Flange coupling PFA coated	11056326
Temperature sensor acid resistant	11056329	⑪ Connecting nipple PFA coated	11056328
⑤ Needle 0.7 mm titanium	11056315	Connecting piece PFA coated	11056334
Nozzle tip 0.7 mm titanium	11056317	PTFE Seal SVL 42	003575
Nozzle cap 1.5 mm titanium	11057509	⑫ FEP hose ID 6×1 mm	027900
Needle 1.4 mm titanium	11056417	n.a. O-ring set FFKM	046364
Nozzle tip 1.4 mm titanium	11056419		
Nozzle cap 2.2 mm titanium	11057510		
Needle 2.0 mm titanium	11056422		
Nozzle tip 2.0 mm titanium	11056424		
Nozzle cap 2.8 mm titanium	11057511		

## 11 Declarations and requirements

### 11.1 FCC requirements (for USA and Canada)

English:

This equipment has been tested and found to comply with the limits for a Class A digital device, pursuant to both Part 15 of the FCC Rules and the radio interference regulations of the Canadian Department of Communications. These limits are designed to provide reasonable protection against harmful interference when the equipment is operated in a commercial environment.

This equipment generates, uses and can radiate radio frequency energy and, if not installed and used in accordance with the instruction manual, may cause harmful interference to radio communications. Operation of this equipment in a residential area is likely to cause harmful interference in which case the user will be required to correct the interference at his own expense.

Français:

Cet appareil a été testé et s'est avéré conforme aux limites prévues pour les appareils numériques de classe A et à la partie 15 des réglementations FCC ainsi qu'à la réglementation des interférences radio du Canadian Department of Communications. Ces limites sont destinées à fournir une protection adéquate contre les interférences néfastes lorsque l'appareil est utilisé dans un environnement commercial.

Cet appareil génère, utilise et peut irradier une énergie à fréquence radioélectrique, il est en outre susceptible d'engendrer des interférences avec les communications radio, s'il n'est pas installé et utilisé conformément aux instructions du mode d'emploi. L'utilisation de cet appareil dans les zones résidentielles peut causer des interférences néfastes, auquel cas l'exploitant sera amené à prendre les dispositions utiles pour palier aux interférences à ses propres frais.

## 11.2 Safety certificate

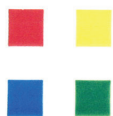

## Certificate

We

Swiss Institute for the Promotion of Safety and Security  
 (Swiss Institute of Safety and Security)  
 Schwarzwaldallee 215  
 WRO 1055.524  
 CH- 4002 Basel

hereby declare that the

**Büchi Mini- Spray Dryer B-290** in combination with the **Büchi Inert Loop B- 295**  
 of the company

Büchi Labortechnik AG  
 Meierseggstrasse 40  
 CH- 9230 Flawil

is safe to operate flammable solvents of explosion group AII and BII under inert  
 conditions and within the defined parameters.

The system has a controlled inert loop and provides a high level protection  
 according the actual state of the art. The safety concept applied is the primary  
 explosion protection measure, avoidance of explosive atmosphere, which follows  
 the preferred recommendation of the applicable guidelines.

A detailed risk analysis has been performed and proofed to be correct by the  
 Swiss Safety Institute. This certificate is based on conclusions of a detailed  
 expertise Nr. 03.GZ.004.301679 of 20. January 2003.

SWISS SAFETY INSTITUTE  
 Affiliate Basel

Andreas Gitzi  
 Safety Engineer [EIV]  
 Explosion Protection

Dr. Martin Glor  
 Member of the Executive committee  
 Head Risk Management Process Safety

Basel, 2008-10-13 (reprint)

Swiss Institute for the Promotion of Safety & Security  
 WRO-1055.524, CH-4002 Basel, Tel +41 -61 696 25 01, Fax +41 -61 696 70 72  
 Explosion Protection – Electrostatic – Fire Protection – Occupational Health  
 Process Safety – Thermal Stability



BUCHI Affiliates:

Europe

Switzerland/Austria

BUCHI Labortechnik AG  
CH – 9230 Flawil  
T +41 71 394 63 63  
F +41 71 394 64 64  
buchi@buchi.com  
www.buchi.com

Italy

BUCHI Italia s.r.l.  
IT – 20010 Cornaredo (MI)  
T +39 02 824 50 11  
F +39 02 575 12 855  
italia@buchi.com  
www.buchi.com/it-it

Benelux

BUCHI Labortechnik GmbH  
Branch Office Benelux  
NL – 3342 GT Hendrik-Ido-Ambacht  
T +31 78 684 94 29  
F +31 78 684 94 30  
benelux@buchi.com  
www.buchi.com/bx-en

Russia

BUCHI Russia/CIS  
Russia 127287 Moscow  
T +7 495 36 36 495  
russia@buchi.com  
www.buchi.com/ru-ru

France

BUCHI Sarl  
FR – 94656 Rungis Cedex  
T +33 1 56 70 62 50  
F +33 1 46 86 00 31  
france@buchi.com  
www.buchi.com/fr-fr

United Kingdom

BUCHI UK Ltd.  
GB – Oldham OL9 9QL  
T +44 161 633 1000  
F +44 161 633 1007  
uk@buchi.com  
www.buchi.com/gb-en

Germany

BUCHI Labortechnik GmbH  
DE – 45127 Essen  
T +800 414 0 414 0 (Toll Free)  
T +49 201 747 49 0  
F +49 201 747 49 20  
deutschland@buchi.com  
www.buchi.com/de-de

Germany

BUCHI NIR-Online  
DE – 69190 Walldorf  
T +49 6227 73 26 60  
F +49 6227 73 26 70  
nir-online@buchi.com  
www.nir-online.de

America

Brazil

BUCHI Brasil Ltda.  
BR – Valinhos SP 13271-200  
T +55 19 3849 1201  
F +55 19 3849 2907  
brasil@buchi.com  
www.buchi.com/br-pt

USA/Canada

BUCHI Corporation  
US – New Castle, DE 19720  
T +1 877 692 8244 (Toll Free)  
T +1 302 652 3000  
F +1 302 652 8777  
us-sales@buchi.com  
www.buchi.com/us-en

Asia

China

BUCHI China  
CN – 200233 Shanghai  
T +86 21 6280 3366  
F +86 21 5230 8821  
china@buchi.com  
www.buchi.com/cn-zh

India

BUCHI India Private Ltd.  
IN – Mumbai 400 055  
T +91 22 667 75400  
F +91 22 667 18986  
india@buchi.com  
www.buchi.com/in-en

Indonesia

PT. BUCHI Indonesia  
ID – Tangerang 15321  
T +62 21 537 62 16  
F +62 21 537 62 17  
indonesia@buchi.com  
www.buchi.com/id-in

Japan

Nihon BUCHI K.K.  
JP – Tokyo 110-0008  
T +81 3 3821 4777  
F +81 3 3821 4555  
nihon@buchi.com  
www.buchi.com/jp-ja

Korea

BUCHI Korea Inc.  
KR – Seoul 153-782  
T +82 2 6718 7500  
F +82 2 6718 7599  
korea@buchi.com  
www.buchi.com/kr-ko

Malaysia

BUCHI Malaysia Sdn. Bhd.  
MY – 47301 Petaling Jaya,  
Selangor  
T +60 3 7832 0310  
F +60 3 7832 0309  
malaysia@buchi.com  
www.buchi.com/my-en

Singapore

BUCHI Singapore Pte. Ltd.  
SG – Singapore 609919  
T +65 6565 1175  
F +65 6566 7047  
singapore@buchi.com  
www.buchi.com/sg-en

Thailand

BUCHI (Thailand) Ltd.  
TH – Bangkok 10600  
T +66 2 862 08 51  
F +66 2 862 08 54  
thailand@buchi.com  
www.buchi.com/th-th

BUCHI Support Centers:

South East Asia

BUCHI (Thailand) Ltd.  
TH-Bangkok 10600  
T +66 2 862 08 51  
F +66 2 862 08 54  
bacc@buchi.com  
www.buchi.com/th-th

Middle East

BUCHI Labortechnik AG  
UAE – Dubai  
T +971 4 313 2860  
F +971 4 313 2861  
middleeast@buchi.com  
www.buchi.com

Latin America

BUCHI Latinoamérica Ltda.  
BR – Valinhos SP 13271-200  
T +55 19 3849 1201  
F +55 19 3849 2907  
latinoamerica@buchi.com  
www.buchi.com/es-es

We are represented by more than 100 distribution partners worldwide.  
Find your local representative at: [www.buchi.com](http://www.buchi.com)